



**Alabama Department of Environmental Management**  
**adem.alabama.gov**

1400 Coliseum Blvd. 36110-2400 ■ Post Office Box 301463  
Montgomery, Alabama 36130-1463  
(334) 271-7700 ■ FAX (334) 271-7950

September 23, 2022

Mr. David Reed  
President  
Whitaker Contracting Corp.  
P. O. Box 306  
Guntersville, AL 35976

RE: Draft Permit  
Brooksville Sand Quarry  
NPDES Permit Number AL0075680  
Blount County (009)

Dear Mr.Reed:

Transmitted herein is a draft of the above referenced permit. Please review the enclosed draft permit carefully. If previously permitted, the draft may contain additions/revisions to the language in your current permit. Please submit any comments on the draft permit to the Department within 30 days from the date of receipt of this letter.

Since the Department has made a tentative decision to reissue and modify the above referenced permit, ADEM Admin. Code r. 335-6-6-.21 requires a public notice of the draft permit followed by a period of at least 30 days for public comment before the permit can be issued. The United States Environmental Protection Agency will also receive the draft permit for review during the 30-day public comment period.

Any mining, processing, construction, land disturbance, or other regulated activity proposed to be authorized by this draft permit is prohibited prior to the effective date of the formal permit. Any mining or processing activity within the drainage basin associated with each permitted outfall which is conducted prior to Departmental receipt of certification from a professional engineer licensed to practice in the State of Alabama, that the Pollution Abatement/Prevention Plan was implemented according to the design plan, or notification from the Alabama Surface Mining Commission that the sediment control structures have been certified, is prohibited.

This permit requires Discharge Monitoring Reports (DMR) to be submitted utilizing the Department's web-based electronic reporting system. Please read Part I.D of the permit carefully and visit <https://aepacs.adem.alabama.gov/nviro/ncore/external/home>.

Should you have any questions concerning this matter, please contact Clint Dear at (334) 274-4238 or [clint.dear@adem.alabama.gov](mailto:clint.dear@adem.alabama.gov).

Sincerely,

James H. Carlson, Chief  
Stormwater Management Branch  
Water Division

JHC/cdd File: DPER/20446

cc: Clint Dear, ADEM  
Environmental Protection Agency Region IV  
Alabama Department of Conservation and Natural Resources  
U.S. Fish and Wildlife Service  
Alabama Historical Commission  
Advisory Council on Historic Preservation  
Alabama Department of Labor





# NATIONAL POLLUTANT DISCHARGE ELIMINATION SYSTEM PERMIT

PERMITTEE: Whitaker Contracting Corp.  
Post Office Box 306  
Guntersville, AL 35976

FACILITY LOCATION: Brooksville Sand Quarry  
222 Jones Road  
Blountsville, AL 35031  
Blount County  
T10S, R2E, S16, S17

PERMIT NUMBER: AL0075680

DSN & RECEIVING STREAM:	001 - 1	Unnamed Tributary to Mill Branch
	002 - 1	Unnamed Tributary to Mill Branch
	003 - 1	Unnamed Tributary to Mill Branch
	004 - 1	Mill Branch
	005 - 1	Mill Branch
	006 - 1	Unnamed Tributary to Big Spring Creek
	007 - 1	Unnamed Tributary to Big Spring Creek
	008 - 1	Unnamed Tributary to Big Spring Creek

*In accordance with and subject to the provisions of the Federal Water Pollution Control Act, as amended, 33 U.S.C. §§1251-1388 (the "FWPCA"), the Alabama Water Pollution Control Act, as amended, Code of Alabama 1975, §§ 22-22-1 to 22-22-14 (the "AWPCA"), the Alabama Environmental Management Act, as amended, Code of Alabama 1975, §§22-22A-1 to 22-22A-17, and rules and regulations adopted thereunder, and subject further to the terms and conditions set forth in this permit, the Permittee is hereby authorized to discharge into the above-named receiving waters.*

ISSUANCE DATE:

EFFECTIVE DATE:

EXPIRATION DATE:

## DRAFT

Alabama Department of Environmental Management

**MINING AND NATURAL RESOURCE SECTION**  
**NATIONAL POLLUTANT DISCHARGE ELIMINATION SYSTEM (NPDES) PERMIT**

**TABLE OF CONTENTS**

<b>PART I</b>	<b>DISCHARGE LIMITATIONS, CONDITIONS, AND REQUIREMENTS</b>	
A.	DISCHARGE LIMITATIONS AND MONITORING REQUIREMENTS.....	4
B.	REQUIREMENTS TO ACTIVATE A PROPOSED MINING OUTFALL.....	4
C.	DISCHARGE MONITORING AND RECORD KEEPING REQUIREMENTS .....	4
1.	Sampling Schedule and Frequency.....	4
2.	Measurement Frequency .....	5
3.	Monitoring Schedule.....	5
4.	Sampling Location.....	6
5.	Representative Sampling .....	6
6.	Test Procedures .....	6
7.	Recording of Results .....	7
8.	Routine Inspection by Permittee.....	7
9.	Records Retention and Production.....	8
10.	Monitoring Equipment and Instrumentation .....	8
D.	DISCHARGE REPORTING REQUIREMENTS.....	8
1.	Requirements for Reporting of Monitoring.....	8
2.	Noncompliance Notification .....	10
3.	Reduction, Suspension, or Termination of Monitoring and/or Reporting.....	11
E.	OTHER REPORTING AND NOTIFICATION REQUIREMENTS .....	12
1.	Anticipated Noncompliance.....	12
2.	Termination of Discharge.....	12
3.	Updating Information .....	12
4.	Duty to Provide Information .....	13
F.	SCHEDULE OF COMPLIANCE.....	13
<b>PART II</b>	<b>OTHER REQUIREMENTS, RESPONSIBILITIES, AND DUTIES</b>	
A.	OPERATIONAL AND MANAGEMENT REQUIREMENTS.....	14
1.	Facilities Operation and Management .....	14
2.	Pollution Abatement and/or Prevention Plan .....	14
3.	Best Management Practices (BMPs).....	14
4.	Biocide Additives.....	15
5.	Facility Identification .....	16
6.	Removed Substances .....	16
7.	Loss or Failure of Treatment Facilities .....	16
8.	Duty to Mitigate.....	16
B.	BYPASS AND UPSET .....	16
1.	Bypass.....	16
2.	Upset.....	17
C.	PERMIT CONDITIONS AND RESTRICTIONS.....	18
1.	Prohibition against Discharge from Facilities Not Certified .....	18
2.	Permit Modification, Suspension, Termination, and Revocation .....	19
3.	Automatic Expiration of Permits for New or Increased Discharges.....	19
4.	Transfer of Permit.....	20

5. Groundwater .....	20
6. Property and Other Rights.....	20
<b>D. RESPONSIBILITIES .....</b>	<b>21</b>
1. Duty to Comply .....	21
2. Change in Discharge .....	21
3. Compliance with Toxic or Other Pollutant Effluent Standard or Prohibition .....	22
4. Compliance with Water Quality Standards and Other Provisions.....	22
5. Compliance with Statutes and Rules .....	22
6. Right of Entry and Inspection.....	23
7. Duty to Reapply or Notify of Intent to Cease Discharge.....	23

**PART III ADDITIONAL REQUIREMENTS, CONDITIONS, AND LIMITATIONS**

<b>A. CIVIL AND CRIMINAL LIABILITY.....</b>	<b>24</b>
1. Tampering.....	24
2. False Statements .....	24
3. Permit Enforcement.....	24
4. Relief From Liability.....	24
<b>B. OIL AND HAZARDOUS SUBSTANCE LIABILITY.....</b>	<b>24</b>
<b>C. AVAILABILITY OF REPORTS.....</b>	<b>24</b>
<b>D. DEFINITIONS .....</b>	<b>24</b>
<b>E. SEVERABILITY.....</b>	<b>29</b>
<b>F. PROHIBITIONS AND ACTIVIES NOT AUTHORIZED.....</b>	<b>29</b>
<b>G. DISCHARGES TO IMPAIRED WATERS.....</b>	<b>29</b>

## PART I DISCHARGE LIMITATIONS, CONDITIONS, AND REQUIREMENTS

### A. DISCHARGE LIMITATIONS AND MONITORING REQUIREMENTS

During the period beginning on the effective date of this Permit and lasting through the expiration date of this Permit, the Permittee is authorized to discharge from each point source identified on Page 1 of this Permit and described more fully in the Permittee's application, if the outfalls have been constructed and certified. Discharges shall be limited and monitored by the Permittee as specified below:

Parameter	Discharge Limitations			Monitoring Requirements	
	Daily Minimum	Monthly Average	Daily Maximum	Sample Type	Measurement Frequency <sup>1</sup>
pH 00400	6.0 s.u.	-----	9.0 s.u.	Grab	2/Month
pH 00400 (Outfall 002-1)	6.0 s.u.	-----	8.5 s.u.	Grab	2/Month
Solids, Total Suspended 00530	-----	25.0 mg/L	45.0 mg/L	Grab	2/Month
Flow, In Conduit or Thru Treatment Plant <sup>2</sup> 50050	-----	Report MGD	Report MGD	Instantaneous	2/Month

### B. REQUIREMENTS TO ACTIVATE A PROPOSED MINING OUTFALL

1. Discharge from any point source identified on Page 1 of this Permit which is a proposed outfall is not authorized by this Permit until the outfall has been constructed and certification received by the Department from a professional engineer, registered in the State of Alabama, certifying that such facility has been constructed according to good engineering practices and in accordance with the Pollution Abatement and/or Prevention (PAP) Plan.
2. Certification required by Part I.B.1. shall be submitted on a completed ADEM Form 432. The certification shall include the latitude and longitude of the constructed and certified outfall.
3. Discharge monitoring and Discharge Monitoring Report (DMR) reporting requirements described in Part I.C. of this Permit do not apply to point sources that have not been constructed and certified.
4. Upon submittal of the certification required by Part I.B.1. to the Department, all monitoring and DMR submittal requirements shall apply to the constructed and certified outfall.

### C. DISCHARGE MONITORING AND RECORD KEEPING REQUIREMENTS

#### 1. Sampling Schedule and Frequency

- a. The Permittee shall collect at least one grab sample of the discharge to surface waters from each constructed and certified point source identified on Page 1 of this Permit and described more fully in the Permittee's application twice per month at a rate of at least every other week if a discharge occurs at any time during the two week period, but need

<sup>1</sup> See Part I.C.2. for further measurement frequency requirements.

<sup>2</sup> Flow must be determined at the time of sample collection by direct measurement, calculation, or other method acceptable to the Department.

not collect more than two samples per calendar month. Each sample collected shall be analyzed for each parameter specified in Part I.A. of this Permit.

- b. If the final effluent is pumped in order to discharge (e.g. from incised ponds, old highwall cuts, old pit areas or depressions, etc.), the Permittee shall collect at least one grab sample of the discharge from each point source identified on Page 1 of this Permit and described more fully in the Permittee's application each quarterly (three month) monitoring period if a discharge occurs at any time during the quarterly monitoring period which results from direct pumped drainage. Each sample collected shall be analyzed for each parameter specified in Part I.A. of this Permit.
- c. The Permittee may increase the frequency of sampling listed in Parts I.C.1.a and I.C.1.b; however, all sampling results must be reported to the Department and included in any calculated results submitted to the Department in accordance with this Permit.

## **2. Measurement Frequency**

Measurement frequency requirements found in Part I.A. shall mean:

- a. A measurement frequency of one day per week shall mean sample collection on any day of discharge which occurs every calendar week.
- b. A measurement frequency of two days per month shall mean sample collection on any day of discharge which occurs every other week, but need not exceed two sample days per month.
- c. A measurement frequency of one day per month shall mean sample collection on any day of discharge which occurs during each calendar month.
- d. A measurement frequency of one day per quarter shall mean sample collection on any day of discharge which occurs during each calendar quarter.
- e. A measurement frequency of one day per six months shall mean sample collection on any day of discharge which occurs during the period of January through June and during the period of July through December.
- f. A measurement frequency of one day per year shall mean sample collection on any day of discharge which occurs during each calendar year.

## **3. Monitoring Schedule**

The Permittee shall conduct the monitoring required by Part I.A. in accordance with the following schedule:

- a. MONITORING REQUIRED MORE FREQUENTLY THAN MONTHLY AND MONTHLY shall be conducted during the first full month following the effective date of coverage under this Permit and every month thereafter. More frequently than monthly and monthly monitoring may be done anytime during the month, unless restricted elsewhere in this Permit, but the results should be reported on the last Discharge Monitoring Report (DMR) due for the quarter (i.e., with the March, June, September, and December DMRs).
- b. QUARTERLY MONITORING shall be conducted at least once during each calendar quarter. Calendar quarters are the periods of January through March, April through June, July through September, and October through December. The Permittee shall conduct the quarterly monitoring during the first complete calendar quarter following the effective date

of this Permit and is then required to monitor once during each quarter thereafter. Quarterly monitoring may be done anytime during the quarter, unless restricted elsewhere in this Permit, but the results should be reported on the last DMR due for the quarter (i.e., with the March, June, September, and December DMRs).

- c. SEMIANNUAL MONITORING shall be conducted at least once during the period of January through June and at least once during the period of July through December. The Permittee shall conduct the semiannual monitoring during the first complete semiannual calendar period following the effective date of this Permit and is then required to monitor once during each semiannual period thereafter. Semiannual monitoring may be done anytime during the semiannual period, unless restricted elsewhere in this Permit, but it should be reported on the last DMR due for the month of the semiannual period (i.e., with the June and December DMRs).
- d. ANNUAL MONITORING shall be conducted at least once during the period of January through December. The Permittee shall conduct the annual monitoring during the first complete calendar annual period following the effective date of this Permit and is then required to monitor once during each annual period thereafter. Annual monitoring may be done anytime during the year, unless restricted elsewhere in this Permit, but it should be reported on the December DMR.

#### **4. Sampling Location**

Unless restricted elsewhere in this Permit, samples collected to comply with the monitoring requirements specified in Part I.A. shall be collected at the nearest accessible location just prior to discharge and after final treatment, or at an alternate location approved in writing by the Department.

#### **5. Representative Sampling**

Sample collection and measurement actions taken as required herein shall be representative of the volume and nature of the monitored discharge and shall be in accordance with the provisions of this Permit.

#### **6. Test Procedures**

For the purpose of reporting and compliance, Permittees shall use one of the following procedures:

- a. For parameters with an EPA established Minimum Level (ML), report the measured value if the analytical result is at or above the ML and report "0" for values below the ML. Test procedures for the analysis of pollutants shall conform to 40 CFR Part 136, guidelines published pursuant to Section 304(h) of the FWPCA, 33 U.S.C. Section 1314(h), and ADEM Standard Operating Procedures. If more than one method for analysis of a substance is approved for use, a method having a minimum level lower than the permit limit shall be used. If the minimum level of all methods is higher than the permit limit, the method having the lowest minimum level shall be used and a report of less than the minimum level shall be reported as zero and will constitute compliance, however should EPA approve a method with a lower minimum level during the term of this Permit the Permittee shall use the newly approved method.
- b. For pollutant parameters without an established ML, an interim ML may be utilized. The interim ML shall be calculated as 3.18 times the Method Detection Level (MDL) calculated pursuant to 40 CFR Part 136, Appendix B.

Permittees may develop an effluent matrix-specific ML, where an effluent matrix prevents attainment of the established ML. However, a matrix specific ML shall be based upon

proper laboratory method and technique. Matrix-specific MLs must be approved by the Department, and may be developed by the Permittee during permit issuance, reissuance, modification, or during compliance schedule.

In either case the measured value should be reported if the analytical result is at or above the ML and "0" reported for values below the ML.

- c. For parameters without an EPA established ML, interim ML, or matrix-specific ML, a report of less than the detection limit shall constitute compliance if the detection limit of all analytical methods is higher than the permit limit using the most sensitive EPA approved method. For the purpose of calculating a monthly average, "0" shall be used for values reported less than the detection limit.

The Minimum Level utilized for procedures identified in Parts I.C.6.a. and b. shall be reported on the Permittee's DMR. When an EPA approved test procedure for analysis of a pollutant does not exist, the Director shall approve the procedure to be used.

## **7. Recording of Results**

For each measurement or sample taken pursuant to the requirements of this Permit, the Permittee shall record the following information:

- a. The facility name and location, point source number, date, time, and exact place of sampling or measurements;
- b. The name(s) of person(s) who obtained the samples or measurements;
- c. The dates and times the analyses were performed;
- d. The name(s) of the person(s) who performed the analyses;
- e. The analytical techniques or methods used including source of method and method number; and
- f. The results of all required analyses.

## **8. Routine Inspection by Permittee**

- a. The Permittee shall inspect all point sources identified on Page 1 of this Permit and described more fully in the Permittee's application and all treatment or control facilities or systems used by the Permittee to achieve compliance with the terms and conditions of this Permit at least as often as the applicable sampling frequency specified in Part I.C.1 of this Permit.
- b. If required by the Director, the Permittee shall maintain a written log for each point source identified on Page 1 of this Permit and described more fully in the Permittee's application in which the Permittee shall record the following information:
  - (1) The date and time the point source and any associated treatment or control facilities or systems were inspected by the Permittee;
  - (2) Whether there was a discharge from the point source at the time of inspection by the Permittee;



- (3) Whether a sample of the discharge from the point source was collected at the time of inspection by the Permittee;
- (4) Whether all associated treatment or control facilities or systems appeared to be in good working order and operating as efficiently as possible, and if not, a description of the problems or deficiencies; and
- (5) The name and signature of the person performing the inspection of the point source and associated treatment or control facilities or systems.

**9. Records Retention and Production**

- a. The Permittee shall retain records of all monitoring information, including all calibration and maintenance records and all original strip chart recordings for continuous monitoring instrumentation, copies of all reports required by this Permit, and records of all data used to complete the above reports or the application for this Permit, for a period of at least three (3) years from the date of the sample collection, measurement, report, or application. This period may be extended by request of the Director at any time. If litigation or other enforcement action, under the AWPCA, AEMA, and/or the FWPCA, is ongoing which involves any of the above records, the records shall be kept until the litigation is resolved. Upon the written request of the Director, the Permittee shall provide the Director with a copy of any record required to be retained by this paragraph. Copies of these records should not be submitted unless requested.
- b. All records required to be kept for a period of three (3) years shall be kept at the permitted facility or an alternate location approved by the Department in writing and shall be available for inspection.

**10. Monitoring Equipment and Instrumentation**

All equipment and instrumentation used to determine compliance with the requirements of this Permit shall be installed, maintained, and calibrated in accordance with the manufacturer's instructions or, in the absence of manufacturer's instructions, in accordance with accepted practices. The Permittee shall develop and maintain quality assurance procedures to ensure proper operation and maintenance of all equipment and instrumentation. The quality assurance procedures shall include the proper use, maintenance, and installation, when appropriate, of monitoring equipment at the plant site.

**D. DISCHARGE REPORTING REQUIREMENTS**

**1. Requirements for Reporting of Monitoring**

- a. Monitoring results obtained during the previous three (3) months shall be summarized for each month on a Discharge Monitoring Report (DMR) Form approved by the Department, and submitted to the Department so that it is received by the Director no later than the 28<sup>th</sup> day of the month following the quarterly reporting period (i.e., on the 28<sup>th</sup> day of January, April, July, and October of each year).
- b. The Department utilizes a web-based electronic reporting system for submittal of DMRs. **Except as allowed by Part I.D.1.c. or d., the Permittee shall submit all DMRs required by Part I.D.1.a. by utilizing the Department's current electronic reporting system.** The Department's current reporting system, Alabama Environmental Permitting and Compliance System (AEPACS), can be found online at <https://aepacs.adem.alabama.gov/nviro/ncore/external/home>.

- c. If the electronic reporting system is down (i.e. electronic submittal of DMR data is unable to be completed due to technical problems originating with the Department's system; this could include entry/submittal issues with an entire set of DMRs or individual parameters), permittees are not relieved of their obligation to submit DMR data to the Department by the required submittal date. However, if the electronic reporting system is down on the 28th day of the month or is down for an extended period of time as determined by the Department when a DMR is required to be submitted, the facility may submit the data in an alternate manner and format acceptable to the Department. Preapproved alternate acceptable methods include faxing, e-mailing, mailing, or hand-delivery of data such that they are received by the required reporting date. Within five calendar days of the electronic reporting system resuming operation, the Permittee shall enter the data into the reporting system unless an alternate timeframe is approved by the Department. An attachment should be included with the electronic DMR submittal verifying the original submittal date (date of the fax, copy of dated e-mail, or hand-delivery stamped date).
- d. The permittee may submit a request to the Department for a temporary electronic reporting waiver for DMR submittals. The waiver request should include the permit number; permittee name; facility/site name; facility address; name, address, and contact information for the responsible official or duly authorized representative; a detailed statement regarding the basis for requesting such a waiver; and the duration for which the waiver is requested. Approved electronic reporting waivers are not transferrable. Permittees with an approved electronic reporting waiver for DMRs may submit hard copy DMRs for the period that the approved electronic reporting waiver request is effective. The Permittee shall submit the Department-approved DMR forms to the address listed in Part I.D.1.i.
- e. If the Permittee, using approved analytical methods as specified in Part I.C.6., monitors any discharge from a point source identified on Page 1 of this Permit and describe more fully in the Permittee's application more frequently than required by this Permit; the results of such monitoring shall be included in the calculation and reporting of values on the DMR Form, and the increased frequency shall be indicated on the DMR Form.
- f. In the event no discharge from a point source identified on Page 1 of this Permit and described more fully in the Permittee's application occurs during a monitoring period, the Permittee shall report "No Discharge" for such period on the appropriate DMR Form.
- g. Each DMR Form submitted by the Permittee to the Department in accordance with Part I.D.1. must be legible and bear an original signature or electronic signature. Photo and electronic copies of the signature are not acceptable and shall not satisfy the reporting requirements of this Permit.
- h. All reports and forms required to be submitted by this Permit, the AWPCA, and the Department's rules and regulations, shall be signed by a "responsible official" of the Permittee as defined in ADEM Admin. Code r. 335-6-6-.09 or a "duly authorized representative" of such official as defined in ADEM Admin. Code r. 335-6-6-.09 and shall bear the following certification:

"I certify under penalty of law that this document and all attachments were prepared under my direction or supervision in accordance with a system designed to assure that qualified personnel properly gather and evaluate the information submitted. Based on my inquiry of the person or persons who manage the system, or those persons directly responsible for gathering the information, the information submitted is, to the best of my knowledge and belief, true, accurate, and complete. I am aware that there are significant penalties for submitting false

information, including the possibility of fine and imprisonment for knowing violations."

- i. All DMRs, reports, and forms required to be submitted by this Permit, the AWPCA and the Department's rules and regulations, shall be submitted through the Department's electronic reporting system, AEPACS, or, if in hardcopy, shall be addressed to:

Alabama Department of Environmental Management  
Water Division, Mining and Natural Resource Section  
Post Office Box 301463  
Montgomery, Alabama 36130-1463

Certified and Registered Mail shall be addressed to:

Alabama Department of Environmental Management  
Water Division, Mining and Natural Resource Section  
1400 Coliseum Boulevard  
Montgomery, Alabama 36110-2059

- j. Unless authorized in writing by the Department, approved reporting forms required by this Permit or the Department are not to be altered, and if copied or reproduced, must be consistent in format and identical in content to the ADEM approved form. Unauthorized alteration, falsification, or use of incorrectly reproduced forms constitutes noncompliance with the requirements of this Permit and may significantly delay processing of any request, result in denial of the request, result in permit termination, revocation, suspension, modification, or denial of a permit renewal application, or result in other enforcement action.
- k. If this Permit is a reissuance, then the Permittee shall continue to submit DMRs in accordance with the requirements of their previous permit until such time as DMRs are due as discussed in Part I.D.1.

## 2. Noncompliance Notification

- a. The Permittee must notify the Department if, for any reason, the Permittee's discharge:
  - (1) Potentially threatens human health or welfare;
  - (2) Potentially threatens fish or aquatic life;
  - (3) Causes an in-stream water quality criterion to be exceeded;
  - (4) Does not comply with an applicable toxic pollutant effluent standard or prohibition established under Section 307(a) of the FWPCA, 33 U.S.C. §1317(a);
  - (5) Contains a quantity of a hazardous substance which has been determined may be harmful to the public health or welfare under Section 311(b)(4) of the FWPCA, 33 U.S.C. §1321(b)(4); or
  - (6) Exceeds any discharge limitation for an effluent parameter as a result of an unanticipated bypass or upset.

The Permittee shall orally or electronically report any of the above occurrences, describing the circumstances and potential effects of such discharge to the Director within 24-hours

after the Permittee becomes aware of the occurrence of such discharge. In addition to the oral or electronic report, the Permittee shall submit to the Director a written report as provided in Part I.D.2.c., no later than five (5) days after becoming aware of the occurrence of such discharge.

- b. If for any reason, the Permittee's discharge does not comply with any limitation of this Permit, the Permittee shall submit a written report to the Director as provided in Part I.D.2.c. This report must be submitted with the next Discharge Monitoring Report required to be submitted by Part I.D.1. of this Permit after becoming aware of the occurrence of such noncompliance.
- c. Any written report required to be submitted to the Director in accordance with Parts I.D.2.a. and b. shall be submitted using a Noncompliance Notification Form (ADEM Form 421) available on the Department's website (<http://adem.alabama.gov/DeptForms/Form421.pdf>) and include the following information:
  - (1) A description of the discharge and cause of noncompliance;
  - (2) The period of noncompliance, including exact dates and times, or if not corrected, the anticipated time the noncompliance is expected to continue; and
  - (3) A description of the steps taken and/or being taken to reduce or eliminate the noncomplying discharge and to prevent its recurrence.

### **3. Reduction, Suspension, or Termination of Monitoring and/or Reporting**

- a. The Director may, with respect to any point source identified on Page 1 of this Permit and described more fully in the Permittee's application, authorize the Permittee to reduce, suspend, or terminate the monitoring and/or reporting required by this Permit upon the submission of a written request for such reduction, suspension, or termination by the Permittee provided:
  - (1) All mining, processing, or disturbance in the drainage basin(s) associated with the discharge has ceased and site access is adequately restricted or controlled to preclude unpermitted and unauthorized mining, processing, transportation, or associated operations/activity;
  - (2) Permanent, perennial vegetation has been re-established on all areas mined or disturbed for at least one year since mining has ceased in the drainage basin(s) associated with the surface discharge, or all areas have been permanently graded such that all drainage is directed back into the mined pit to preclude all surface discharges;
  - (3) Unless waived in writing by the Department, the Permittee has been granted, in writing, a 100% Bond Release, if applicable, by the Alabama Department of Industrial Relations and, if applicable, by the Surface Mining Commission for all areas mined or disturbed in the drainage basin(s) associated with the discharge;
  - (4) Unless waived in writing by the Department, the Permittee has submitted inspection reports prepared and certified by a Professional Engineer (PE) registered in the State of Alabama or a qualified professional under the PE's direction which certify that the facility has been fully reclaimed or that water quality remediation has been achieved. The first inspection must be conducted approximately one year prior to and the second inspection must be conducted

within thirty days of the Permittee's request for termination of monitoring and reporting requirements;

- (5) All surface effects of the mining activity such as fuel or chemical tanks, preparation plants or equipment, old tools or equipment, junk or debris, etc., must be removed and disposed of according to applicable state and federal regulations;
  - (6) The Permittee's request for termination of monitoring and reporting requirements contained in this Permit has been supported by monitoring data covering a period of at least six consecutive months or such longer period as is necessary to assure that the data reflect discharges occurring during varying seasonal climatological conditions;
  - (7) The Permittee has stated in its request that the samples collected and reported in the monitoring data submitted in support of the Permittee's request for monitoring termination or suspension are representative of the discharge and were collected in accordance with all Permit terms and conditions respecting sampling times (e.g., rainfall events) and methods and were analyzed in accordance with all Permit terms and conditions respecting analytical methods and procedures;
  - (8) The Permittee has certified that during the entire period covered by the monitoring data submitted, no chemical treatment of the discharge was provided;
  - (9) The Permittee's request has included the certification required by Part I.D.1.e. of this Permit; and
  - (10) The Permittee has certified to the Director in writing as part of the request, its compliance with (1) through (9) above.
- b. It remains the responsibility of the Permittee to comply with the monitoring and reporting requirements of this Permit until written authorization to reduce, suspend, or terminate such monitoring and/or reporting is received by the Permittee from the Director.

## **E. OTHER REPORTING AND NOTIFICATION REQUIREMENTS**

### **1. Anticipated Noncompliance**

The Permittee shall give the Director written advance notice of any planned changes or other circumstances regarding a facility which may result in noncompliance with permit requirements.

### **2. Termination of Discharge**

The Permittee shall notify the Director, in writing, when all discharges from any point source(s) identified on Page 1 of this Permit and described more fully in the Permittee's application have permanently ceased.

### **3. Updating Information**

- a. The Permittee shall inform the Director of any change in the Permittee's mailing address or telephone number or in the Permittee's designation of a facility contact or officer(s) having the authority and responsibility to prevent and abate violations of the AWPCA, the AEMA, the Department's rules and regulations, and the terms and conditions of this Permit, in writing, no later than ten (10) days after such change. Upon request of the Director, the

Permittee shall furnish the Director with an update of any information provided in the permit application.

- b. If the Permittee becomes aware that it failed to submit any relevant facts in a permit application, or submitted incorrect information in a permit application or in any report to the Director, it shall promptly submit such facts or information with a written explanation for the mistake and/or omission.

**4. Duty to Provide Information**

- a. The Permittee shall furnish to the Director, within a reasonable time, any information which the Director may request to determine whether cause exists for modifying, suspending, terminating, or revoking and reissuing this Permit, in whole or in part, or to determine compliance with this Permit. The Permittee shall also furnish to the Director upon request, copies of records required to be maintained by this Permit.
- b. The Permittee shall furnish to the Director upon request, within a reasonable time, available information (name, phone number, address, and site location) which identifies offsite sources of material or natural resources (mineral, ore, or other material such as iron, coal, coke, dirt, chert, shale, clay, sand, gravel, bauxite, rock, stone, etc.) used in its operation or stored at the facility.

**F. SCHEDULE OF COMPLIANCE**

The Permittee shall achieve compliance with the discharge limitations specified in Part I.A. of this Permit in accordance with the following schedule:

**Compliance must be achieved by the effective date of this Permit.**

## **PART II OTHER REQUIREMENTS, RESPONSIBILITIES, AND DUTIES**

### **A. OPERATIONAL AND MANAGEMENT REQUIREMENTS**

#### **1. Facilities Operation and Management**

The Permittee shall at all times operate and maintain all facilities and systems of treatment and control (and related appurtenances) which are installed or used by the Permittee to achieve compliance with the conditions of this Permit. Proper operation and maintenance includes effective performance, adequate funding, adequate operator staffing and training, and adequate laboratory and process controls, including appropriate quality assurance procedures. This provision requires the operation of backup or auxiliary facilities only when necessary to achieve compliance with the conditions of this Permit.

#### **2. Pollution Abatement and/or Prevention Plan**

The Pollution Abatement and/or Prevention (PAP) Plan shall be prepared and certified by a registered Professional Engineer (PE), licensed to practice in the State of Alabama, and shall include at a minimum, the information indicated in ADEM Admin. Code r. 335-6-9-.03 and ADEM Admin. Code ch. 335-6-9 Appendices A and B. The PAP Plan shall become a part of this Permit and all requirements of the PAP Plan shall become requirements of this Permit pursuant to ADEM Admin. Code r. 335-6-9-.05(2).

#### **3. Best Management Practices (BMPs)**

- a. Unless otherwise authorized in writing by the Director, the Permittee shall provide a means of subsurface withdrawal for any discharge from each point source identified on Page 1 of this Permit and described more fully in the Permittee's application. Notwithstanding the above provision, a means of subsurface withdrawal need not be provided for any discharge caused by a 24-hour precipitation event greater than a 10-year, 24-hour precipitation event.
- b. Dilution water shall not be added to achieve compliance with discharge limitations except when the Director has granted prior written authorization for dilution to meet water quality requirements.
- c. The Permittee shall minimize the contact of water with overburden, including but not limited to stabilizing disturbed areas through grading, diverting runoff, achieving quick growing stands of temporary vegetation, sealing acid-forming and toxic-forming materials, and maximizing placement of waste materials in back-fill areas.
- d. The Permittee shall prepare, submit to the Department for approval, and implement a Best Management Practices (BMPs) Plan for containment of any or all process liquids or solids, in a manner such that these materials do not present a potential for discharge, if so required by the Director. When submitted and approved, the BMP Plan shall become a part of this Permit and all requirements of the BMP Plan shall become requirements of this Permit.
- e. Spill Prevention, Control, and Management

The Permittee shall prepare, implement, and maintain a Spill Prevention, Control and Countermeasures (SPCC) Plan acceptable to the Department that is prepared and certified by a Professional Engineer (PE), registered in the State of Alabama, for all onsite petroleum product or other pollutant storage tanks or containers as provided by ADEM Admin. Code r. 335-6-6-.08(j)5. The Plan shall describe and the Permittee shall implement appropriate structural and/or non-structural spill prevention, control, and/or management pursuant to

ADEM Admin. Code r. 335-6-6-.12 (r) sufficient to prevent any spills of pollutants from entering a ground or surface water of the State or a publicly or privately owned treatment works. The Plan shall include at a minimum, the engineering requirements provided in 40 C.F.R. §§112.1. Any containment system used to implement this requirement shall be constructed of materials compatible with the substance(s) contained and shall prevent the contamination of groundwater. Such containment systems shall be capable of retaining a volume equal to 110 percent of the capacity of the largest tank for which containment is provided. The Plan shall list any materials which the Permittee may utilize to contain and to absorb fuel and chemical spills and leaks. The Permittee shall maintain sufficient amounts of such materials onsite or have sufficient amounts of such materials readily available to contain and/or absorb fuel and chemical spills and leaks. Soil contaminated by chemical spills, oil spills, etc., must be immediately cleaned up or be removed and disposed of in a manner consistent with all State and federal regulations.

- f. All surface drainage and storm water runoff which originate within or enters the Permittee's premises and which contains any pollutants or other wastes shall be discharged, if at all, from a point source identified on Page 1 of this Permit and described more fully in the Permittee's application.
- g. The Permittee shall take all reasonable precautions to prevent any surface drainage or storm water runoff which originates outside the Permittee's premises and which contains any pollutants or other wastes from entering the Permittee's premises. At no time shall the Permittee discharge any such surface drainage or storm water runoff which enters the Permittee's premises if, either alone or in combination with the Permittee's effluent, the discharge would exceed any applicable discharge limitation specified in Part I.A. of this Permit.

#### **4. Biocide Additives**

- a. The Permittee shall notify the Director in writing not later than sixty (60) days prior to instituting the use of any biocide corrosion inhibitor or chemical additive in any cooling or boiler system(s) regulated by this Permit. Notification is not required for additives that should not reasonably be expected to cause the cooling water or boiler water to exhibit toxicity as determined by analysis of manufacturer's data or testing by the Permittee. Such notification shall include:
  - (a) Name and general composition of biocide or chemical;
  - (b) 96-hour median tolerance limit data for organisms representative of the biota of the water(s) which the discharge(s) enter(s);
  - (c) Quantities to be used;
  - (d) Frequencies of use;
  - (e) Proposed discharge concentrations; and
  - (f) EPA registration number, if applicable.
- b. The use of any biocide or chemical additive containing tributyl tin, tributyl tin oxide, zinc, chromium, or related compounds in any cooling or boiler system(s) regulated by the Permit is prohibited except as exempted below. The use of a biocide or additive containing zinc, chromium or related compounds may be used in special circumstances if (1) the permit contains limits for these substances, or (2) the applicant demonstrates during the application process that the use of zinc, chromium or related compounds as a biocide or



additive will not pose a reasonable potential to violate the applicable State water quality standards for these substances. The use of any additive, not identified in this Permit or in the application for this Permit or not exempted from notification under this Permit is prohibited, prior to a determination by the Department that permit modification to control discharge of the additive is not required or prior to issuance of a permit modification controlling discharge of the additive.

**5. Facility Identification**

The Permittee shall clearly display prior to commencement of any regulated activity and until permit coverage is properly terminated, the name of the Permittee, entire NPDES permit number, facility or site name, and other descriptive information deemed appropriate by the Permittee at an easily accessible location(s) to adequately identify the site, unless approved otherwise in writing by the Department. The Permittee shall repair or replace the sign(s) as necessary upon becoming aware that the identification is missing or is unreadable due to age, vandalism, theft, weather, or other reason.

**6. Removed Substances**

Solids, sludges, filter backwash, or any other pollutants or other wastes removed in the course of treatment or control of wastewaters shall be disposed of in a manner that complies with all applicable Department rules and regulations.

**7. Loss or Failure of Treatment Facilities**

Upon the loss or failure of any treatment facility, including but not limited to the loss or failure of the primary source of power of the treatment facility, the Permittee shall, where necessary to maintain compliance with the discharge limitations specified in Part I.A. of this Permit or any other terms or conditions of this Permit, cease, reduce, or otherwise control production and/or discharges until treatment is restored.

**8. Duty to Mitigate**

The Permittee shall promptly take all reasonable steps to minimize or prevent any violation of this Permit or to mitigate and minimize any adverse impact to waters resulting from noncompliance with any discharge limitation specified in Part I.A. of this Permit, including such accelerated or additional monitoring of the discharge and/or the receiving waterbody as is necessary to determine the nature and impact of the noncomplying discharge.

**B. BYPASS AND UPSET**

**1. Bypass**

- a. Any bypass is prohibited except as provided in Parts II.B.1.b. and c.
- b. A bypass is not prohibited if:
  - (1) It does not cause any applicable discharge limitation specified in Part I.A. of this Permit to be exceeded;
  - (2) The discharge resulting from such bypass enters the same receiving water as the discharge from the permitted outfall;

- (3) It is necessary for essential maintenance of a treatment or control facility or system to assure efficient operation of such facility or system; and
  - (4) The Permittee monitors the discharge resulting from such bypass at a frequency, at least daily, sufficient to prove compliance with the discharge limitations specified in Part I.A. of this Permit.
- c. A bypass is not prohibited and need not meet the discharge limitations specified in Part I.A. of this Permit if:
- (1) It is unavoidable to prevent loss of life, personal injury, or severe property damage;
  - (2) There are no feasible alternatives to the bypass, such as the use of auxiliary treatment facilities, retention of untreated wastes, or maintenance during normal periods of equipment downtime. This condition is not satisfied if the Permittee could have installed adequate backup equipment to prevent a bypass which occurred during normal periods of equipment downtime or preventive maintenance; and
  - (3) The Permittee submits a written request for authorization to bypass to the Director at least ten (10) days, if possible, prior to the anticipated bypass or within 24 hours of an unanticipated bypass, the Permittee is granted such authorization, and Permittee complies with any conditions imposed by the Director to minimize any adverse impact to waters resulting from the bypass.
- d. The Permittee has the burden of establishing that each of the conditions of Parts II.B.1.b. or c. have been met to qualify for an exception to the general prohibition against bypassing contained in Part II.B.1.a. and an exemption, where applicable, from the discharge limitations specified in Part I.A. of this Permit.

## 2. Upset

- a. The Permittee may seek to demonstrate that noncompliance with technology-based effluent limits occurred as a result of an upset if the conditions of Part II.B.2.b are met and if the Permittee complies with the conditions provided in Part II.B.2.c.
- b. If the Permittee wishes to establish the affirmative defense of an upset for technology-based effluent limit noncompliance, the Permittee must demonstrate through properly signed, contemporaneous operating logs, or other relevant evidence that:
  - (1) An upset occurred and that the Permittee can identify the specific cause(s) of the upset;
  - (2) The wastewater treatment facility was at the time being properly operated in accordance with Part II.B.d.
  - (3) The Permittee submitted notice of the noncompliance during the upset as required by Part II.B.2.c; and
  - (4) The Permittee complied with any remedial measures required under Part II.A.7. of this Permit.
- c. If the Permittee wishes to establish the affirmative defense of an upset for technology-based effluent limit noncompliance, the Permittee shall:

- (1) No later than 24-hours after becoming aware of the occurrence of the upset, orally report the occurrence and circumstances of the upset to the Director in accordance with Part I.G.2.; and
  - (2) No later than five (5) days after becoming aware of the occurrence of the upset, furnish the Director with evidence, including properly signed, contemporaneous operating logs, design drawings, construction certification, maintenance records, weir flow measurements, dated photographs, rain gauge measurements, or other relevant evidence, demonstrating that:
    - (i) An upset occurred;
    - (ii) The Permittee can identify the specific cause(s) of the upset;
    - (iii) The Permittee's treatment facility was being properly operated at the time of the upset; and
    - (iv) The Permittee promptly took all reasonable steps to minimize any adverse impact to waters resulting from the upset.
- d. A discharge which is an overflow from a treatment facility or system, or an excess discharge from a point source associated with a treatment facility or system and which results from a 24-hour precipitation event larger than a 10-year, 24-hour precipitation event is not eligible to be considered as a result of an upset unless:
- (1) The treatment facility or system is designed, constructed, and maintained to contain the maximum volume of wastewater which would be generated by the facility during a 24-hour period without an increase in volume from precipitation and the maximum volume of wastewater resulting from a 10-year, 24-hour precipitation event or to treat the maximum flow associated with these volumes. In computing the maximum volume of wastewater which would result from a 10-year, 24-hour precipitation event, the volume which would result from all areas contributing runoff to the individual treatment facility must be included (i.e., all runoff that is not diverted from the mining area and runoff which is not diverted from the preparation plant area); and
  - (2) The Permittee takes all reasonable steps to maintain treatment of the wastewater and minimize the amount of overflow or excess discharge.
- e. The Permittee has the burden of proof in defense of any enforcement action as a result of noncompliance of technology-based effluent limits the Permittee proposes to attribute to an upset.

## **C. PERMIT CONDITIONS AND RESTRICTIONS**

### **1. Prohibition against Discharge from Facilities Not Certified**

- a. Notwithstanding any other provisions of this Permit, if the permitted facility has not obtained or is not required to obtain a permit from the Alabama Surface Mining Commission, any discharge(s) from any point or nonpoint source(s) from the permitted facility which was not certified to the Department on a form approved by the Department by a professional engineer, registered in the State of Alabama, as being designed,

constructed, and in accordance with plans and specifications reviewed by the Department is prohibited; or

- b. Notwithstanding any other provisions of this Permit, if the permitted facility has obtained or is required to obtain a permit from the Alabama Surface Mining Commission, any discharge(s) from any point or nonpoint source(s) from the permitted facility which is associated with a treatment facility which was not constructed and certified to the Alabama Surface Mining Commission pursuant to applicable provisions of said Commission's regulations, is prohibited until the Permittee submits to the Alabama Surface Mining Commission, certification by a professional engineer, registered in the State of Alabama, certifying that such facility has been constructed in accordance with plans and specifications approved by the Alabama Surface Mining Commission. This requirement shall not apply to pumped discharges from the underground works of underground coal mines where no surface structure is required by the Alabama Surface Mining Commission, provided the Department is notified in writing of the completion or installation of such facilities, and the pumped discharges will meet permit effluent limits without treatment.

## **2. Permit Modification, Suspension, Termination, and Revocation**

- a. This Permit may be modified, suspended, terminated, or revoked and reissued, in whole or in part, during its term for cause, including but not limited to, the following:
  - (1) The violation of any term or condition of this Permit;
  - (2) The obtaining of this Permit by misrepresentation or the failure to disclose fully all relevant facts;
  - (3) The submission of materially false or inaccurate statements or information in the permit application or reports required by the Permit;
  - (4) The need for a change in any condition that requires either a temporary or permanent reduction or elimination of the permitted discharge;
  - (5) The existence of any typographical or clerical errors or of any errors in the calculation of discharge limitations;
  - (6) The existence of material and substantial alterations or additions to the facility or activity generating wastewater which occurred after permit issuance which justify the application of permit conditions that are different or absent in the existing permit;
  - (7) The threat of the Permittee's discharge on human health or welfare; or
  - (8) Any other cause allowed by ADEM Admin. Code ch. 335-6-6.
- b. The filing of a request by the Permittee for modification, suspension, termination, or revocation and reissuance of this Permit, in whole or in part, does not stay any Permit term or condition of this Permit.

## **3. Automatic Expiration of Permits for New or Increased Discharges**

- a. Except as provided by ADEM Admin. Code r. 335-6-6-.02(h) and 335-6-6-.05, if this Permit was issued for a new discharger or new source, it shall expire eighteen months after the issuance date if construction has not begun during that eighteen month period.
- b. Except as provided by ADEM Admin. Code r. 335-6-6-.02(h) and 335-6-6-.05, if any portion of this Permit was issued or modified to authorize the discharge of increased quantities of pollutants to accommodate the modification of an existing facility, that portion of this Permit shall expire eighteen months after this Permit's issuance if construction of the modification has not begun within eighteen month period.
- c. Construction has begun when the owner or operator has:
  - (1) Begun, or caused to begin as part of a continuous on-site construction program:
    - (i) Any placement, assembly, or installation of facilities or equipment; or
    - (ii) Significant site preparation work including clearing, excavation, or removal of existing buildings, structures, or facilities which is necessary for the placement, assembly, or installation of new source facilities or equipment; or
  - (2) Entered into a binding contractual obligation for the purpose of placement, assembly, or installation of facilities or equipment which are intended to be used in its operation within a reasonable time. Options to purchase or contracts which can be terminated or modified without substantial loss, and contracts for feasibility, engineering, and design studies do not constitute a contractual obligation under the paragraph. The entering into a lease with the State of Alabama for exploration and production of hydrocarbons shall also be considered beginning construction.
- d. The automatic expiration of this Permit for new or increased discharges if construction has not begun within the eighteen month period after the issuance of this Permit may be tolled by administrative or judicial stay.

#### **4. Transfer of Permit**

This Permit may not be transferred or the name of the Permittee changed without notice to the Director and subsequent modification or revocation and reissuance of this Permit to identify the new Permittee and to incorporate any other changes as may be required under the FWPCA or AWPCA. In the case of a change in name, ownership, or control of the Permittee's premises only, a request for permit modification in a format acceptable to the Director is required at least 30 days prior to the change. In the case of a change in name, ownership, or control of the Permittee's premises accompanied by a change or proposed change in effluent characteristics, a complete permit application is required to be submitted to the Director at least 180 days prior to the change. Whenever the Director is notified of a change in name, ownership, or control, he may decide not to modify the existing Permit and require the submission of a new permit application.

#### **5. Groundwater**

Unless authorized on page 1 of this Permit, this Permit does not authorize any discharge to groundwater. Should a threat of groundwater contamination occur, the Director may require groundwater monitoring to properly assess the degree of the problem, and the Director may require that the Permittee undertake measures to abate any such discharge and/or contamination.

#### **6. Property and Other Rights**

This Permit does not convey any property rights in either real or personal property, or any exclusive privileges, nor does it authorize any injury to persons or property or invasion of other private rights, trespass, or any infringement of Federal, State, or local laws or regulations, nor does it authorize or approve the construction of any physical structures or facilities or the undertaking of any work in any waters of the State or of the United States.

## **D. RESPONSIBILITIES**

### **1. Duty to Comply**

- a. The Permittee must comply with all terms and conditions of this Permit. Any permit noncompliance constitutes a violation of the AWPCA, AEMA, and the FWPCA and is grounds for enforcement action, for permit termination, revocation and reissuance, suspension, modification, or denial of a permit renewal application.
- b. The Permittee shall comply with effluent standards or prohibitions established under Section 307(a) of the FWPCA for toxic pollutants within the time provided in the regulations that establish these standards or prohibitions, even if this Permit has not yet been modified to incorporate the effluent standard, prohibition or requirement.
- c. For any violation(s) of this Permit, the Permittee is subject to a civil penalty as authorized by the AWPCA, the AEMA, the FWPCA, and Code of Alabama 1975, §§22-22A-1 et. seq., as amended, and/or a criminal penalty as authorized by Code of Alabama 1975, §22-22-1 et. seq., as amended.
- d. The necessity to halt or reduce production or other activities in order to maintain compliance with the conditions of this Permit shall not be a defense for a Permittee in an enforcement action.
- e. Nothing in this Permit shall be construed to preclude or negate the Permittee's responsibility or liability to apply for, obtain, or comply with other ADEM, federal, state, or local government permits, certifications, licenses, or other approvals.
- f. The discharge of a pollutant from a source not specifically identified in the permit application for this Permit and not specifically included in the description of an outfall in this Permit is not authorized and shall constitute noncompliance with this Permit.
- g. The Permittee shall take all reasonable steps, including cessation of production or other activities, to minimize or prevent any violation of this Permit or to minimize or prevent any adverse impact of any permit violation.

### **2. Change in Discharge**

- a. The Permittee shall apply for a permit modification at least 180 days in advance of any facility expansion, production increase, process change, or other action that could result in the discharge of additional pollutants, increase the quantity of a discharged pollutant, or that could result in an additional discharge point. This requirement also applies to pollutants that are not subject to discharge limitations in this Permit. No new or increased discharge may begin until the Director has authorized it by issuance of a permit modification or a reissued permit.
- b. The Permittee shall notify the Director as soon as it knows or has reason to believe that it has begun or expects to begin to discharge any pollutant listed as a toxic pollutant pursuant

to Section 307(a) of the FWPCA, 33 U.S.C. §1317(a), any substance designated as a hazardous substance pursuant to Section 311(b)(2) of the FWPCA, 33 U.S.C. §1321(b)(2), any waste listed as a hazardous waste pursuant to Code of Alabama 1975, §22-30-10, or any other pollutants or other wastes which is not subject to any discharge limitations specified in Part I.A. of this Permit and was not reported in the Permittee's application, was reported in the Permittee's application in concentrations or mass rates lower than that which the Permittee expects to begin to be discharged, or has reason to believe has begun to be discharged.

**3. Compliance with Toxic or Other Pollutant Effluent Standard or Prohibition**

If any applicable effluent standard or prohibition (including any schedule of compliance specified in such effluent standard or prohibition) is established under Sections 301(b)(2)(C),(D),(E) and (F) of the FWPCA, 33 U.S.C. §1311(b)(2)(C),(D),(E), and (F); 304(b)(2) of the FWPCA, 33 U.S.C. §1314(b)(2); or 307(a) of the FWPCA, 33 U.S.C. §1317(a), for a toxic or other pollutant discharged by the Permittee, and such standard or prohibition is more stringent than any discharge limitation on the pollutant specified in Part I.A. of this Permit or controls a pollutant not limited in Part I.A. of this Permit, this Permit shall be modified to conform to the toxic or other pollutant effluent standard or prohibition and the Permittee shall be notified of such modification. If this Permit has not been modified to conform to the toxic or other pollutant effluent standard or prohibition before the effective date of such standard or prohibition, the authorization to discharge in this Permit shall be void to the extent that any discharge limitation on such pollutant in Part I.A. of this Permit exceeds or is inconsistent with the established toxic or other pollutant effluent standard or prohibition.

**4. Compliance with Water Quality Standards and Other Provisions**

- a. On the basis of the Permittee's application, plans, or other available information, the Department has determined that compliance with the terms and conditions of this Permit will assure compliance with applicable water quality standards. However, this Permit does not relieve the Permittee from compliance with applicable State water quality standards established in ADEM Admin. Code ch. 335-6-10, and does not preclude the Department from taking action as appropriate to address the potential for contravention of applicable State water quality standards which could result from discharges of pollutants from the permitted facility.
- b. Compliance with Permit terms and conditions notwithstanding, if the Permittee's discharge(s) from point source(s) identified on Page 1 of this Permit cause(s) or contribute(s) to a condition in contravention of State water quality standards, the Department may require abatement action to be taken by the Permittee, modify the Permit pursuant to the Department's rules and regulations, or both.
- c. If the Department determines, on the basis of a notice provided pursuant to Part II.C.2. of this Permit or any investigation, inspection, or sampling, that a modification of this Permit is necessary to assure maintenance of water quality standards or compliance with other provisions of the AWPCA or FWPCA, the Department may require such modification and, in cases of emergency, the Director may prohibit the noticed act until the Permit has been modified.

**5. Compliance with Statutes and Rules**

- a. This Permit has been issued under ADEM Admin. Code div. 335-6. All provisions of this division, that are applicable to this Permit, are hereby made a part of this Permit. A copy of this division may be obtained for a small charge from the Office of General Counsel, Alabama Department of Environmental Management, 1400 Coliseum Blvd., Montgomery, AL 36110-2059.

- b. This Permit does not authorize the noncompliance with or violation of any Laws of the State of Alabama or the United States of America or any regulations or rules implementing such laws. FWPCA, 33 U.S.C. Section 1319, and Code of Alabama 1975, Section 22-22-14.

**6. Right of Entry and Inspection**

The Permittee shall allow the Director, or an authorized representative, upon the presentation of credentials and other documents as may be required by law to:

- a. Enter upon the Permittee's premises where a regulated facility or activity is located or conducted, or where records must be kept under the conditions of the Permit;
- b. Have access to and copy, at reasonable times, any records that must be kept under the conditions of this Permit;
- c. Inspect at reasonable times any facilities, equipment (including monitoring and control equipment), practices, or operations regulated or required under this Permit; and
- d. Sample or monitor at reasonable times, for the purposes of assuring Permit compliance or as otherwise authorized by the AWPCA, any substances or parameters at any location.

**7. Duty to Reapply or Notify of Intent to Cease Discharge**

- a. If the Permittee intends to continue to discharge beyond the expiration date of this Permit, the Permittee shall file with the Department a complete permit application for reissuance of this Permit at least 180 days prior to its expiration. **Applications must be submitted electronically via the Department's current electronic permitting system. The Department's current online permitting system, Alabama Environmental Permitting and Compliance System (AEPACS), can be found online at <https://aepacs.adem.alabama.gov/nviro/ncore/external/home>.**
- b. If the Permittee does not desire to continue the discharge(s) allowed by this Permit, the Permittee shall notify the Department at least 180 days prior to expiration of this Permit of the Permittee's intention not to request reissuance of this Permit. This notification must include the information required in Part I.D.4.a. and be signed by an individual meeting the signatory requirements for a permit application as set forth in ADEM Admin. Code r. 335-6-6-.09.
- c. Failure of the Permittee to submit to the Department a complete application for reissuance of this Permit at least 180 days prior to the expiration date of this Permit will void the automatic continuation of this Permit provided by ADEM Admin. Code r. 335-6-6-.06; and should this Permit not be reissued for any reason, any discharge after the expiration of this Permit will be an unpermitted discharge.



## **PART III ADDITIONAL REQUIREMENTS, CONDITIONS, AND LIMITATIONS**

### **A. CIVIL AND CRIMINAL LIABILITY**

#### **1. Tampering**

Any person who falsifies, tampers with, or knowingly renders inaccurate any monitoring device or method required to be maintained or performed under this Permit shall, upon conviction, be subject to penalties and/or imprisonment as provided by the AWPCA and/or the AEMA.

#### **2. False Statements**

Any person who knowingly makes any false statement, representation, or certification in any record or other document submitted or required to be maintained under this Permit, including monitoring reports or reports of compliance or noncompliance shall, upon conviction, be punished as provided by applicable State and Federal law.

#### **3. Permit Enforcement**

This NPDES Permit is a Permit for the purpose of the AWPCA, the AEMA, and the FWPCA, and as such all terms, conditions, or limitations of this Permit are enforceable under State and Federal law.

#### **4. Relief From Liability**

Except as provided in Part II.B.1. (Bypass) and Part II.B.2. (Upset), nothing in this Permit shall be construed to relieve the Permittee of civil or criminal liability under the AWPCA, AEMA, or FWPCA for noncompliance with any term or condition of this Permit.

### **B. OIL AND HAZARDOUS SUBSTANCE LIABILITY**

Nothing in this Permit shall be construed to preclude the institution of any legal action or relieve the Permittee from any responsibilities, liabilities, or penalties to which the Permittee is or may be subject to under Section 311 of the FWPCA, 33 U.S.C. §1321.

### **C. AVAILABILITY OF REPORTS**

Except for data determined to be confidential under Code of Alabama 1975, §22-22-9(c), all reports prepared in accordance with the terms of this Permit shall be available for public inspection at the offices of the Department. Effluent data shall not be considered confidential. Knowingly making any false statement in any such report may result in the imposition of criminal penalties as provided for in Section 309 of the FWPCA, 33 U.S.C. §1319, and Code of Alabama 1975, §22-22-14.

### **D. DEFINITIONS**

1. Alabama Environmental Management Act (AEMA) - means Code of Alabama 1975, §§22-22A-1 et. seq., as amended.
2. Alabama Water Pollution Control Act (AWPCA) - means Code of Alabama 1975, §§22-22-1 et. seq., as amended.
3. Average monthly discharge limitation - means the highest allowable average of "daily discharges" over a calendar month, calculated as the sum of all "daily discharges" measured during a calendar

month divided by the number of "daily discharges" measured during that month (zero discharge days shall not be included in the number of "daily discharges" measured and a less than detectable test result shall be treated as a concentration of zero if the most sensitive EPA approved method was used).

4. Arithmetic Mean - means the summation of the individual values of any set of values divided by the number of individual values.
5. BOD - means the five-day measure of the pollutant parameter biochemical oxygen demand
6. Bypass - means the intentional diversion of waste streams from any portion of a treatment facility.
7. CBOD - means the five-day measure of the pollutant parameter carbonaceous biochemical oxygen demand.
8. Controlled Surface Mine Drainage – means any surface mine drainage that is pumped or siphoned from the active mining area.
9. Crushed stone mine - means an area on or beneath land which is mined, quarried, or otherwise disturbed in activity related to the extraction, removal, or recovery of stone from natural or artificial deposits, including active mining, reclamation, and mineral storage areas, for production of crushed stone.
10. Daily discharge - means the discharge of a pollutant measured during any consecutive 24-hour period in accordance with the sample type and analytical methodology specified by the discharge permit.
11. Daily maximum - means the highest value of any individual sample result obtained during a day.
12. Daily minimum - means the lowest value of any individual sample result obtained during a day.
13. Day - means any consecutive 24-hour period.
14. Department - means the Alabama Department of Environmental Management.
15. Director - means the Director of the Department or his authorized representative or designee.
16. Discharge - means "[t]he addition, introduction, leaking, spilling or emitting of any sewage, industrial waste, pollutant or other waste into waters of the state." Code of Alabama 1975, §22-22-1(b)(8).
17. Discharge monitoring report (DMR) - means the form approved by the Director to accomplish monitoring report requirements of an NPDES Permit.
18. DO - means dissolved oxygen.
19. E. coli – means the pollutant parameter Escherichia coli.
20. 8HC - means 8-hour composite sample, including any of the following:
  - a. The mixing of at least 5 equal volume samples collected at constant time intervals of not more than 2 hours over a period of not less than 8 hours between the hours of 6:00 a.m. and 6:00 p.m. If the sampling period exceeds 8 hours, sampling may be conducted beyond the 6:00 a.m. to 6:00 p.m. period.

- b. A sample continuously collected at a constant rate over period of not less than 8 hours between the hours of 6:00 a.m. and 6:00 p.m. If the sampling period exceeds 8 hours, sampling may be conducted beyond the 6:00 a.m. to 6:00 p.m. period.
21. EPA - means the United States Environmental Protection Agency.
22. Federal Water Pollution Control Act (FWPCA) - means 33 U.S.C. §§1251 et. seq., as amended.
23. Flow – means the total volume of discharge in a 24-hour period.
24. Geometric Mean - means the Nth root of the product of the individual values of any set of values where N is equal to the number of individual values. The geometric mean is equivalent to the antilog of the arithmetic mean of the logarithms of the individual values. For purposes of calculating the geometric mean, values of zero (0) shall be considered one (1).
25. Grab Sample - means a single influent or effluent portion which is not a composite sample. The sample(s) shall be collected at the period(s) most representative of the discharge.
26. Indirect Discharger - means a nondomestic discharger who discharges pollutants to a publicly owned treatment works or a privately owned treatment facility operated by another person.
27. Industrial User - means those industries identified in the Standard Industrial Classification manual, Bureau of the Budget 1967, as amended and supplemented, under the category “Division D – Manufacturing” and such other classes of significant waste producers as, by regulation, the Director deems appropriate.
28. mg/L - means milligrams per liter of discharge.
29. MGD - means million gallons per day.
30. Monthly Average - means, other than for E. coli bacteria, the arithmetic mean of all the composite or grab samples taken for the daily discharges collected in one month period. The monthly average for E. coli bacteria is the geometric mean of daily discharge samples collected in a one month period. The monthly average for flow is the arithmetic mean of all flow measurements taken in a one month period. (Zero discharges shall not be included in the calculation of monthly averages.)
31. New Discharger - means a person owning or operating any building, structure, facility or installation:
- a. From which there is or may be a discharge of pollutants;
  - b. From which the discharge of pollutants did not commence prior to August 13, 1979, and which is not a new source; and
  - c. Which has never received a final effective NPDES Permit for dischargers at that site.
32. New Source - means:
- a. A new source as defined for coal mines by 40 CFR Part 434.11 (1994); and
  - b. Any building, structure, facility, or installation from which there is or may be a discharge of pollutants, the construction of which commenced:
    - (1) After promulgation of standards of performance under Section 306 of FWPCA which are applicable to such source; or

- (2) After proposal of standards of performance in accordance with Section 306 of the FWPCA which are applicable to such source, but only if the standards are promulgated in accordance with Section 206 within 120 days of their proposal.
33. NH<sub>3</sub>-N - means the pollutant parameter ammonia, measured as nitrogen.
34. 1-year, 24-hour precipitation event - means the maximum 24-hour precipitation event with a probable recurrence interval of once in one year as defined by the National Weather Service and Technical Paper No. 40, "Rainfall Frequency Atlas of the U.S.," May 1961, or equivalent regional or rainfall probability information developed therefrom.
35. Permit application - means forms and additional information that are required by ADEM Admin. Code r. 335-6-6-.08 and applicable permit fees.
36. Point Source - means "any discernible, confined and discrete conveyance, including but not limited to any pipe, channel, ditch, tunnel, conduit, well, discrete fissure, container, rolling stock, concentrated animal feeding operation, or vessel or other floating craft from which pollutants are or may be discharged." Section 502(14) of the FWPCA, 33 U.S.C. §1362(14).
37. Pollutant - includes for purposes of this Permit, but is not limited to, those pollutants specified in Code of Alabama 1975, §22-22-1(b)(3) and those effluent characteristics, excluding flow, specified in Part I.A. of this Permit.
38. Pollutant of Concern - means those pollutants for which a water body is listed as impaired or which contribute to the listed impairment.
39. Pollution Abatement and/or Prevention Plan (PAP Plan) – mining operations plan developed to minimize impacts on water quality to avoid a contravention of the applicable water quality standards as defined in ADEM Admin. Code r. 335-6-9-.03
40. Preparation, Dry - means a dry preparation facility within which the mineral/material is cleaned, separated, or otherwise processed without use of water or chemical additives before it is shipped to the customer or otherwise utilized. A dry preparation plant includes all ancillary operations and structures necessary to clean, separate, or otherwise process the mineral/material, such as storage areas and loading facilities. Dry preparation also includes minor water spray(s) used solely for dust suppression on equipment and roads to minimize dust emissions.
41. Preparation, Wet - means a wet preparation facility within which the mineral/material is cleaned, separated, or otherwise processed using water or chemical additives before it is shipped to the customer or otherwise utilized. A wet preparation plant includes all ancillary operations and structures necessary to clean, separate, or otherwise process the mineral/material, such as storage areas and loading facilities. Wet preparation also includes mineral extraction/processing by dredging, slurry pumping, etc.
42. Privately Owned Treatment Works - means any devices or system which is used to treat wastes from any facility whose operator is not the operator of the treatment works, and which is not a "POTW".
43. Publicly Owned Treatment Works (POTW) - means a wastewater collection and treatment facility owned by the State, municipality, regional entity composed of two or more municipalities, or another entity created by the State or local authority for the purpose of collecting and treating municipal wastewater.
44. Receiving Stream - means the "waters" receiving a "discharge" from a "point source".

45. Severe property damage - means substantial physical damage to property, damage to the treatment facilities which causes them to become inoperable, or substantial and permanent loss of natural resources which can reasonably be expected to occur in the absence of a bypass. Severe property damage does not mean economic loss caused by delays in production.
46. 10-year, 24-hour precipitation event - means that amount of precipitation which occurs during the maximum 24-hour precipitation event with a probable recurrence interval of once in ten years as defined by the National Weather Service and Technical Paper No. 40, "Rainfall Frequency Atlas of the U.S.," May 1961, or equivalent regional or rainfall probability information developed therefrom.
47. TKN - means the pollutant parameter Total Kjeldahl Nitrogen.
48. TON - means the pollutant parameter Total Organic Nitrogen.
49. TRC - means Total Residual Chlorine.
50. TSS – means the pollutant parameter Total Suspended Solids
51. Treatment facility and treatment system - means all structures which contain, convey, and as necessary, chemically or physically treat mine and/or associated preparation plant drainage, which remove pollutants limited by this Permit from such drainage or wastewater. This includes all pipes, channels, ponds, tanks, and all other equipment serving such structures.
52. 24HC - means 24-hour composite sample, including any of the following:
  - a. The mixing of at least 12 equal volume samples collected at constant time intervals of not more than 2 hours over a period of 24 hours;
  - b. A sample collected over a consecutive 24-hour period using an automatic sampler composite to one sample. As a minimum, samples shall be collected hourly and each shall be no more than one twenty-fourth (1/24) of the total sample volume collected; or
  - c. A sample collected over a consecutive 24-hour period using an automatic composite sampler composited proportional to flow.
53. 24-hour precipitation event - means that amount of precipitation which occurs within any 24-hour period.
54. 2-year, 24-hour precipitation event - means the maximum 24-hour precipitation event with a probable recurrence interval of once in two years as defined by the National Weather Service and Technical Paper No. 40, "Rainfall Frequency Atlas of the U.S.," May 1961, or equivalent regional or rainfall probability information developed therefrom.
55. Upset - means an exceptional incident in which there is an unintentional and temporary noncompliance with technology-based permit discharge limitations because of factors beyond the control of the Permittee. An upset does not include noncompliance to the extent caused by operational error, improperly designed treatment facilities, inadequate facilities, lack of preventive maintenance, or careless or improper operation.
56. Waters - means "[a]ll waters of any river, stream, watercourse, pond, lake, coastal, ground or surface water, wholly or partially within the State, natural or artificial. This does not include waters which are entirely confined and retained completely upon the property of a single individual, partnership, or corporation unless such waters are used in interstate commerce." Code of Alabama 1975, §22-22-1(b)(2). "Waters" include all "navigable waters" as defined in §502(7) of the FWPCA, 33 U.S.C. §1362(7), which are within the State of Alabama.

57. Week - means the period beginning at twelve midnight Saturday and ending at twelve midnight the following Saturday.
58. Weekly (7-day and calendar week) Average – is the arithmetic mean of all samples collected during a consecutive 7-day period or calendar week, whichever is applicable. The calendar week is defined as beginning on Sunday and ending on Saturday. Weekly averages shall be calculated for all calendar weeks with Saturdays in the month. If a calendar week overlaps two months (i.e., the Sunday is in one month and the Saturday in the following month), the weekly average calculated for the calendar week shall be included in the data for the month that contains the Saturday.

## **E. SEVERABILITY**

The provisions of this Permit are severable, and if any provision of this Permit or the application of any provision of this Permit to any circumstance, is held invalid, the application of such provision to other circumstances, and the remainder of this Permit, shall not be affected thereby.

## **F. PROHIBITIONS AND ACTIVITIES NOT AUTHORIZED**

1. Discharges from disposal or landfill activities as described in ADEM Admin. Code div. 335-13 are not authorized by this Permit unless specifically approved by the Department.
2. Relocation, diversion, or other alteration of a water of the State is not authorized by this Permit unless specifically approved by the Department.
3. Lime or cement manufacturing or production and discharge of process waters from such manufacturing or production is not authorized by this Permit unless specifically approved by the Department.
4. Concrete or asphalt manufacturing or production and discharge of process waters from such manufacturing or production is not authorized by this Permit unless specifically approved by the Department.
5. The discharge of wastewater, generated by any process, facility, or by any other means not under the operational control of the Permittee or not identified in the application for this Permit or not identified specifically in the description of an outfall in this Permit is not authorized by this Permit.

## **G. DISCHARGES TO IMPAIRED WATERS**

1. This Permit does not authorize new sources or new discharges of pollutants of concern to impaired waters unless consistent with an EPA-approved or EPA-established Total Maximum Daily Load (TMDL) and applicable State law, or unless compliance with the limitations and requirements of the Permit ensure that the discharge will not contribute to further degradation of the receiving stream. Impaired waters are those that do not meet applicable water quality standards and are identified on the State of Alabama's §303(d) list or on an EPA-approved or EPA-established TMDL. Pollutants of concern are those pollutants for which the receiving water is listed as impaired or contribute to the listed impairment.
2. Facilities that discharge into a receiving stream which is listed on the State of Alabama's §303(d) list of impaired waters, and with discharges that contain the pollutant(s) for which the waters are impaired, must within six (6) months of the Final §303(d) list approval, document in its BMP plan how the BMPs will control the discharge of the pollutant(s) of concern, and must ensure that there will be no increase of the pollutants of concern. A monitoring plan to assess the effectiveness of the BMPs in achieving the allocations must also be included in the BMP plan.

3. If the facility discharges to impaired waters as described above, it must determine whether a TMDL has been developed and approved or established by EPA for the listed waters. If a TMDL is approved or established during this Permit cycle by EPA for any waters into which the facility discharges, the facility must review the applicable TMDL to see if it includes requirements for control of any water discharged by the Permittee. Within six (6) months of the date of TMDL approval or establishment, the facility must notify the Department on how it will modify its BMP plan to include best management practices specifically targeted to achieve the allocations prescribed by the TMDL, if necessary. Any revised BMP plans must be submitted to the Department for review. The facility must include in the BMP plan a monitoring component to assess the effectiveness of the BMPs in achieving the allocations.

**ALABAMA DEPARTMENT OF ENVIRONMENTAL MANAGEMENT  
WATER DIVISION**

**NPDES INDIVIDUAL PERMIT RATIONALE**

**Company Name:** Whitaker Contracting Corp.

**Facility Name:** Brooksville Sand Quarry

**County:** Blount

**Permit Number:** AL0075680

**Prepared by:** Clint Dear

**Date:** August 26, 2022

**Receiving Waters:** Mill Branch, Unnamed Tributary to Mill Branch, and Unnamed Tributary to Big Spring Creek

**Permit Coverage:** Industrial Sand Quarry, Wet and Dry Preparation Plant, Transportation and Storage, and Associated Areas

**SIC Code:** 1429 & 1446

The Department has made a tentative determination that the available information is adequate to support reissuance and modification of this permit. The modification covers the addition of Outfalls 003-1 through 008-1.

This proposed permit covers an industrial sand quarry, wet and dry preparation, transportation and storage, and associated areas which discharge to surface waters of the state. This permit does not cover process generated waste water from operations using hydro-flouride (HF) flotation.

This proposed permit authorizes treated discharges into a stream segment, other State water, or local watershed that currently has a water quality classification of Fish and Wildlife (F&W) (ADEM Admin. Code ch. 335-6-11). If the requirements of the proposed permit are fully implemented, the facility will not discharge pollutants at levels that will cause or contribute to a violation of the F&W classification.

Full compliance with the proposed permit terms and conditions is expected to be protective of instream water quality and ensure consistency with applicable instream State water quality standards (WQS) for the receiving stream.

Technology Based Effluent Limits (TBELs) for industrial sand facilities can be found in 40 CFR 436.42(1), (3), and (4) for facilities that recycle waste water for use in processing, employ HF flotation, and mine dewatering, respectively. The TBELs were promulgated for existing dischargers using the Best Practicable Control Technology Available (BPT). New Source Performance Standards (NSPS) have not yet been developed by the EPA for the Industrial Sand Subcategory.

The instream WQS for pH, for streams classified F&W, are 6.0 - 8.5 s.u per ADEM Admin Code r. 335-6-10-.09; however, because discharges are expected only in response to rain events, it is the opinion of the Department that discharges with an allowable pH daily maximum of 9.0 s.u. will not adversely affect the



instream pH based on the low discharge/stream flow ratio. The proposed discharge limitations for pH of 6.0 – 9.0 s.u. are identical to the existing point source TBELs found in 40 CFR 436 Subpart D. Information provided in the Permittee's application indicated that Outfall 002-1 could discharge chronically when the discharge/stream flow ratio may be high; therefore, discharge limitations for pH of 6.0 – 8.5 s.u. are proposed for Outfall 002 -1 per ADEM Admin Code r. 335-6-10-.09. This is a reduction of the previously permitted pH limits for Outfall 002 -1 of 6.0 – 9.0 s.u.

The proposed effluent limitations for Total Suspended Solids (TSS) were established using the TBELs found in 40 CFR 436.42 and include monthly average and daily maximums of 25 mg/L and 45 mg/L respectively. These parameters are indicative of pollutants typically discharged by a facility covered by this permit and have been found to be protective of water quality.

The applicant has requested, in accordance with 40 CFR Part 122.21 and their NPDES permit application, a waiver from testing for the Part A, B, and C pollutants listed in the EPA Form 2C and 2D that are not addressed in their application. They have also certified that due to the processes involved in their mining activity these pollutants are believed to be not present in the waste stream.

The Pollution Abatement/Prevention (PAP) plan for this facility has been prepared by a professional engineer (PE) registered in the State of Alabama and is designed to ensure reduction of pollutants in the waste stream to a level that, if operated properly, the discharge will not contribute to or cause a violation of applicable State WQS. The proposed permit terms and conditions are predicated on the basis of ensuring a reduction of pollutants in the discharge to a level that reduces the potential of contributing to or causing a violation of applicable State WQS.

In accordance with ADEM Admin. Code r. 335-6-3-.07 the design PE, as evidenced by their seal and/or signature on the application, has accepted full responsibility for the effectiveness of the waste treatment facility to treat the Permittee's effluent to meet NPDES permit limitations and requirements, and to fully comply with Alabama's WQS, when such treatment facilities are properly operated.

If there is a reasonable potential that a pollutant present in the treated discharges from a facility could cause or contribute to a contravention of applicable State WQS above numeric or narrative criteria, 40 CFR Part 122 requires the Department to establish effluent limits using calculated water quality criterion, establish effluent limits on a case-by-case basis using criteria established by EPA, or establish effluent limits based on an indicator parameter. Based on available information, potential pollutants discharged from this facility, if discharged within the concentrations allowed by this permit, would not have a reasonable potential to cause or contribute to a contravention of applicable State WQS.

Pursuant to ADEM Admin. Code r. 335-6-6-.12(r) this permit requires the Permittee to design and implement a Spill Prevention Control and Countermeasures (SPCC) plan for all stored chemicals, fuels and/or stored pollutants that have the potential to discharge to a water of the State. This plan must meet the minimum engineering requirements as defined in 40 CFR Part 112 and must provide for secondary containment adequate to control a potential spill.

The applicant is not proposing discharges of pollutants to a water of the State with an approved Total Maximum Daily Load (TMDL).

The applicant is not proposing discharges into a stream segment or other State water that is included on Alabama's current CWA §303(d) list.

The applicant is not proposing new discharges of pollutant(s) to an ADEM identified Tier I water.

The proposed permit action authorizes new discharges of pollutants to receiving waters determined by the Department to be waters where the quality exceeds levels necessary to support propagation of fish, shellfish, and wildlife and recreation in and on the water (Tier II). Pursuant to ADEM Admin. Code r. 335-6-10 (Antidegradation Policy and Implementation of the Antidegradation Policy), the applicant has submitted and the Department has reviewed and considered information regarding (1) demonstration of necessity/importance, (2) alternatives analysis, and (3) calculations of total annualized costs for technically feasible treatment alternatives regarding the proposed new discharges to Tier II waters. The Department has determined, based on the applicant's demonstration, that the proposed new discharges to the Tier II waters are necessary for important economic or social development in the area in which the waters are located.

ALABAMA DEPARTMENT OF ENVIRONMENTAL MANAGEMENT  
WATER DIVISION

ANTIDegradation RATIONALE

**Company Name:** Whitaker Contracting Corp.  
**Facility Name:** Brooksville Sand Quarry  
**County:** Blount  
**Permit Number:** AL0075680  
**Prepared by:** Clint Dear  
**Date:** August 26, 2022  
**Receiving Waters:** Mill Branch, Unnamed Tributary to Mill Branch, and Unnamed Tributary to Big Spring Creek  
**Stream Category:** Tier II as defined by ADEM Admin. Code 335-6-10-.12  
**Discharge Description:** This proposed permit covers an industrial sand quarry, wet and dry preparation, transportation and storage, and associated areas which discharge to surface waters of the state. This permit does not cover process generated waste water from operations using hydro-flouride (HF) flotation.

**The following preliminary determination was prepared in accordance with ADEM Admin. Code 335-6-10-.12 (7) (c):**

The Department has reviewed the information submitted by applicant in accordance with ADEM Admin. Code 335-6-10-.12(9). The applicant has demonstrated that there are no technically or economically viable treatment options in its alternatives analysis that would completely eliminate a direct discharge.

The permit applicant has indicated that the following economic and social benefits will result from this project:

1. The Permittee expects that the issuance of the above referenced NPDES permit will result in an estimated \$68,000 in state and federal payroll taxes per year.
2. The Permittee expects to employ 8 full time employees and additional support employees if the abovementioned permit is issued.
3. The Permittee states that materials mined from this quarry are used in public work projects such as roadways. Locally supplied materials reduce the cost of these projects and save taxpayers money.

The Department has determined that the discharge proposed by the permit applicant is necessary for important economic and social development in the area of the outfall location in the receiving water.

Reviewed By: 

Date: 9/16/22

# NPDES Individual Permit - Modification/Reissuance - Mining (Form 315)

version 2.5

(Submission #: HPF-B71Y-0T8EQ, version 2)

Digitally signed by:  
GlobalSign RSA OV SSL CA 2018  
Date: 2022.06.24 15:24:40 -05:00  
Reason: Submission Data  
Location: State of Alabama

## Details

---

Submission ID HPF-B71Y-0T8EQ

## Form Input

---

### General Instructions

NPDES Individual Application - Mining and Coalbed Methane Operations - Mod/Reissuance (Form 315/549)

PLEASE CONTACT YOUR ASSIGNED PERMIT CONTACT TO DISCUSS THE TYPE OF MODIFICATION YOU SHOULD APPLY FOR BEFORE COMPLETING THIS FORM.

This form should be used to submit the following permit requests for individually permitted Mining and Coalbed Methane Operations:

Modifications/Reissuances that include Permit Transfers and/or Permittee/Facility Name Changes

Minor Modifications

Major Modifications

Reissuances

Reissuance of a permit on or after the current permit's expiration date

Revocation and Reissuance before the current permit's expiration date

Please complete all questions and attach all necessary documentation as prompted throughout the application process. Incomplete or incorrect information will delay processing.

Applicable Fees:

Minor Modifications

\$3,400 (Mineral/Resource Extraction Mining, Storage Transloading, Dry Processing)

\$3,940 (Wet Preparation, Processing, Beneficiation)

\$3,940 (Coalbed Methane Operations)

Major Modifications

\$5,820 (Mineral/Resource Extraction Mining, Storage Transloading, Dry Processing)

\$6,860 (Wet Preparation, Processing, Beneficiation)

\$6,860 (Coalbed Methane Operations)

Reissuances

\$5,820 (Mineral/Resource Extraction Mining, Storage Transloading, Dry Processing)

\$6,860 (Wet Preparation, Processing, Beneficiation)

\$6,860 (Coalbed Methane Operations)

Potential Add-on Fees for Major Modifications and Reissuances

\$1,015 (Biomonitoring & Toxicity Limits)

\$2,705 (Review of Model Performed by Others)

\$4,855 (Modeling )

[For assistance, please click here to determine the permit staff responsible for the site or call \(334\) 394-4372.](#)

### Processing Information

#### **Purpose of Application**

Reissuance and Modification of Permit Due to Approaching Expiration

Please indicate if the Permittee is applying for a permit transfer and/or name change in addition to permit modification or reissuance:

None

**Action Type**

Reissuance with Modification

Briefly describe any planned changes at the facility that are included in this reissuance application:

Permit area and outfalls are being added to the permit.

CORRECTION REQUEST (CORRECTED)  
**Changes**  
Indicate that outfalls are being added.  
Created on 5/5/2022 11:13 AM by Clint Dear

Is this a coalbed methane operation?

No

**Permit Information**

**Permit Number**

AL0075680

**Current Permittee Name**

Whitaker Contracting Corp.

**Permittee**

**Permittee Name**

Whitaker Contracting Corp.

**Mailing Address**

Post Office Box 306  
Guntersville, AL 35976

**Responsible Official**

**Prefix**

Mr.

**First Name      Last Name**

David              Reed

**Title**

President

**Organization Name**

Whitaker Contracting Corp.

**Phone Type    Number            Extension**

Business        256-582-2636

**Email**

Davidreed@whitaker-contracting.com

**Mailing Address**

P. O. Box 306  
Guntersville, AL 35976

**Existing Permit Contacts**

Affiliation Type	Contact Information	Remove?
Notification Recipient,Responsible Official	David Reed, Whitaker Contracting Corp.	NONE PROVIDED

Affiliation Type	Contact Information	Remove?
DMR Contact	Lynn McWhorther, Whitaker Contracting Corp.	NONE PROVIDED
Permittee	Whitaker Contracting Corp.	NONE PROVIDED

## Facility/Operations Information

### Facility/Operations Name

Brooksville Sand Quarry

### Permittee Organization Type

Corporation

### Parent Corporation and Subsidiary Corporations of Applicant, if any:

None

### Landowner(s) Name, Address and Phone Number:

Madison Materials, Inc. - P. O. Box 306 Guntersville, AL 35976 - 256-582-2636

Jamey E Reed ETAL - P. O. Box 306 Guntersville, AL 35976

Hunter James Mikel Lake - 3825 Cochran St Simi Valley, CA 93063

#### CORRECTION REQUEST (CORRECTED)

#### Landowner Information

List the Name, Address, and Phone Number for all landowners. Provided map shows that the landowners are Madison Materials, Jamey W. Reed, and Hunter James Mikel.

Created on 5/5/2022 11:16 AM by Clint Dear

### Sub-contractor(s)/Operator(s), if known:

None

Is the  Company/Permittee  properly registered and in good standing with the Alabama Secretary of State's office?

Yes

### Facility/Operations Address or Location Description

222 Jones Road

Blountsville, AL 35031

### Facility/Operations County (Front Gate)

Blount

### Do the operations span multiple counties?

No

### Facility/Operations Contact

#### Prefix

Mr.

#### First Name Last Name

Lynn McWhorther

#### Title

Quality Control Supervisor

#### Organization Name

Whitaker Contracting Corp.

#### Phone Type Number Extension

Business 256-582-2636

#### Email

Lynnmcwhorther@whitaker-contracting.com

**Detailed Directions to the Facility/Operations**

From the intersection of Hwy 278 and Hwy 79 in Brooksville, travel SE on Hwy 278 approx. 1.5 miles, turn left on Jones Rd and travel approx. .25 miles, turn right on entrance road to the quarry.

Please refer to the link below for Lat/Long map instruction help:

[Map Instruction Help](#)

**Facility/Operations Front Gate Latitude and Longitude**

34.15805600000000,-86.45222200000001

**Township(s), Range(s), Section(s)** (Note: If you are submitting multiple TRSs, please separate each TRS by a semicolon. Example: T19S,R1E,S15; T20S,R2E,S16)

Sections 16 & 17, Township 10 South, Range 2 East

**SIC Code(s) [Please select your primary SIC code first]:**

1446-Industrial Sand

**NAICS Code(s) [Please select your primary NAICS code first]:**

212322-Industrial Sand Mining

**Member Information**

Identify the name, title/position, and unless waived in writing by the Department, the resident address of every officer (a PO Box is not acceptable), general partner, LLP partner, LLC member, investor, director, or person performing a function similar to a director, of the applicant, and each person who is the record or beneficial owner of 10 percent or more of any class of voting stock of the applicant, or any other responsible official(s) of the applicant with legal or decision making responsibility or authority for the facility/operations (if this does not apply, then enter N/A after selecting "Manually Enter in Table"):

**List of Names/Titles/Addresses will be entered by:**

Manually Entering in Table

Name	Title/Position	Physical Address of Residence
David Reed	President	2140 Wyeth Drive, Guntersville, Alabama 35976

Other than the "Company/Permittee", identify the name of each corporation, partnership, association, and single proprietorship for which any individual identified above is or was an officer, general partner, LLP partner, LLC member, investor, director, or individual performing a function similar to a director, or principal (10% or more) stockholder, that had an Alabama NPDES permit at any time during the five year (60 month) period immediately preceding the date on which this form is signed (if this does not apply, then enter N/A after selecting "Manually Enter in Table"):

**List of Corporations/Partnerships/etc, Names and Titles will be entered by:**

Manually Entering in Table

Name of Corporation, Partnership, Association, or Single Proprietorship	Name of Individual	Title/Position in Corporation, Partnership, Association, or Single Proprietorship
Madison Materials, Inc.	David Reed	President

**Additional Contacts (1 of 1)**

**ADDITIONAL CONTACTS:**

**Contact Type**

NONE PROVIDED

## Contact

**First Name**  
NONE PROVIDED

**Last Name**  
NONE PROVIDED

**Title**  
NONE PROVIDED

**Organization Name**  
NONE PROVIDED

**Phone Type**            **Number**        **Extension**  
NONE PROVIDED

**Email**  
NONE PROVIDED

**Address**  
[NO STREET ADDRESS SPECIFIED]  
[NO CITY SPECIFIED], AL [NO ZIP CODE SPECIFIED]

## Compliance History

**Has the applicant ever had any of the following:**

None apply

**Has the applicant, parent corporation, subsidiary, general partner, LLP partner, or LLC Member had any Warning Letters, Notice of Violations (NOVs), Administrative Actions, or litigation filed by ADEM or EPA during the three year (36 month) period preceding the date on which this form is signed?**

No

**For this facility, list any other NPDES or other environmental permits (including permit numbers), authorizations, or certifications that have been applied for or issued within the State by ADEM, EPA, Alabama Department of Labor (ADOL), US Army Corp of Engineers (USACE), or other agency, to the applicant, parent corporation, subsidiary, or LLC member whether presently effective, expired, suspended, revoked, or terminated:**

ADOL Permit No. 12179, ADEM Air Permit No. 402-0007-X001, 402-0007-X002, 402-0007-X003

**For other facilities, list any other NPDES or other ADEM permits (including permit numbers), authorizations, or certifications that have been applied for or issued within the State by ADEM, EPA, ASMC, ADOL, or USACE, to the applicant, parent corporation, subsidiary, or LLC member whether presently effective, expired, suspended, revoked, or terminated:**

AL0075663, AL0075671, AL0082856, AL0083330, ALG020043, ALG020054, 402-0006-X023, 402-0016-X009, 711-0025-X005, 711-0025-X006, 711-0025-X008, 711-0025-X009, 711-0025-X010, 711-0032-X003

## Anti-Degradation Evaluation

**Pursuant to ADEM Admin. Code ch. 335-6-10-.12(9), responses to the following questions must be provided by the applicant requesting NPDES permit coverage for new or expanded discharges of pollutant(s) to Tier 2 waters (except discharges eligible for coverage under general permits). As part of the permit application review process, the Department is required to consider, based on the applicant's demonstration, whether the proposed new or increased discharge to Tier 2 waters is necessary for important economic or social development in the area in which the waters are located. Does this modification/reissuance include a new outfall?**

Yes

**Has an Anti-Degradation Analysis been previously conducted and submitted to the Department for the new or increased discharge referenced above?**

No

## NOTE

If the discharge is to a Tier II waterbody as defined in ADEM Admin. Code r. 335-6-10-.12(4), complete questions below, ADEM Form 311-Alternatives Analysis, and either ADEM Form 312 or ADEM Form 313- Calculation of Total Annualized Project Costs (Public-Sector or Private-Sector Projects, whichever is applicable). ADEM Form 312 or ADEM Form 313, whichever is applicable, must be provided for each treatment discharge alternative considered technically viable.



[ADEM forms can be found on the Department's website here.](#)

**What environmental or public health problem will the discharger be correcting?**

None

**How much will the discharger be increasing employment (at its existing facility or as the result of locating a new facility)?**

Whitaker Contracting Corp. will employ approximately eight (8) full time employees at the Brooksville Sand Quarry. Additional jobs are created as the result of supplying services to this mine and hauling product from this facility.

**How much reduction in employment will the discharger be avoiding?**

Eight (8) full time jobs. It is expected the reserves proposed to be added by this permit will result in approximately five - eight (5-8) years of mining.

**How much additional state or local taxes will the discharger be paying?**

Whitaker Contracting Corp. averages approximately \$68,000 per year in state and local taxes. The taxes generated are as follows: State severance tax for product produced is approximately \$42,000/yr, employee payroll tax is approximately \$24,000/yr and county sales tax is approximately \$12,000/yr. Fuel taxes are approximately \$8,400/yr. This facility is expected to add approximately 5 to 8 years of additional mining.

**What public service to the community will the discharger be providing?**

The materials mined from this quarry will be used primarily in the production of asphalt and concrete. Many of these materials are used in public works projects such as roads. Locally supplied materials reduce the cost of these public projects and save taxpayers money.

**What economic or social benefit will the discharger be providing to the community?**

Whitaker Contracting Corp. provides a variety of jobs to the local community. These jobs range from laborers to professional. A variety of taxes are paid into the local, state and federal governments. A portion of this money is used in the local school system.

**Attach Form 311 (Alternative Analysis)**

[Form 311.pdf - 02/09/2022 04:18 PM](#)

**Comment**

NONE PROVIDED

**Please attach Form 312 (Public Sector Projects) or Form 313 (Private Sector Projects).**

[Form 313.pdf - 02/08/2022 04:11 PM](#)

**Comment**

NONE PROVIDED

**Activity Description & Information**

**Narrative description of activity(s):**

Whitaker Contracting operates an industrial sand quarry. Surface activities include drilling, blasting, hauling, crushing, screening and transporting the material.

**Total Facility/Operations Area (acres)**

351.00

**Total Disturbed Area (acres)**

351.00

**Anticipated Commencement Date**

07/31/2022

**Anticipated Completion Date**

07/31/2027

**Is/will this operation (please check all that apply):**

An existing facility/operation which currently results in discharges to State waters?  
Need/have ADOL permit coverage?

Does your facility/operation use cooling water?

No

### Material to be Removed, Processed, or Transloaded

Material To Be Removed, Processed, Or Transloaded (Note: Sum must equal 100.)

Mineral(s)/Mineral product(s)	%
Industrial Sand	100
	Sum: 100

**CORRECTION REQUEST (CORRECTED)**

**Material Mined**

For the narrative description of activity, it reads that the Whitaker operates an industrial sand & sandstone quarry. Will sandstone be mined?

Created on 5/5/2022 11:25 AM by Clint Dear

**1 COMMENT**

**Jonathan Whitlock (jwhitlock@mcgehee.org) (6/13/2022 2:10 PM)**

I did confirm that it is only an industrial sand operation.

### Proposed Activity To Be Conducted

Type(s) of activity presently conducted at applicant's existing facility or proposed to be conducted at facility (check all that apply):

- Mineral storing
- Mineral dry processing (crushing & screening)
- Mineral wet preparation
- Mineral loading
- Grading, clearing, grubbing, etc.
- Excavation
- Surface mining
- Quarrying
- Mineral transportation
- Onsite mining debris or equipment storage/disposal
- Pre-mining logging or land clearing

If the type of activity presently conducted or proposed is Mineral Transportation, please specify the following:

Truck

### Fuel - Chemical Handling, Storage, & Spill Prevention Control & Countermeasures (SPCC) Plan

Will fuels, chemicals, compounds, or liquid waste be used or stored onsite?

Yes

Please identify the fuel, chemicals, compounds, or liquid waste and indicate the volume of each:

Volume (gallons)	Contents
6,000	Deisel Fuel
250	Motor Oil
500	Used Oil
55	Hydraulic Oil
55	Grease
250	Transmission Fluid

Volume (gallons)	Contents
8,000	Deisel Fuel
350	Used Oil

#### SPCC Plan

[Brooksville Quarry SPCC Plan.pdf - 06/20/2022 02:46 PM](#)

##### Comment

NONE PROVIDED

#### CORRECTION REQUEST (CORRECTED)

##### Containment Design Plans

Are there any design plans/drawings for the secondary containment that was specified?

Created on 5/5/2022 11:29 AM by **Clint Dear**

##### 1 COMMENT

**Jonathan Whitlock (jwhitlock@mcgehee.org) (6/20/2022 2:47 PM)**

A typical concrete structure drawing was added to the SPCC Plan.

## ASMC Regulated Entities

Is this a coal mining operation regulated by ASMC?

No

## Topographic Map Submittal

### Topographic Map

Attach to this application a 7.5 minute series U.S.G.S. topographic map(s) or equivalent map(s) no larger than, or folded to a size of 8.5 by 11 inches (several pages may be necessary), of the area extending to at least one mile beyond property boundaries. The topographic or equivalent map(s) must include a caption indicating the name of the topographic map, name of the applicant, facility name, county, and township, range, & section(s) where the facility are located. Unless approved in advance by the Department, the topographic or equivalent map(s), at a minimum, must show: a) An accurate outline of the area to be covered by the permit (b) An outline of the facility (c) All existing and proposed disturbed areas (d) Location of intake and discharge areas (e) Proposed and existing discharge points (f) Perennial, intermittent, and ephemeral streams (g) Lakes, springs, water wells, wetlands (h) All known facility dirt/improved access/haul roads (i) All surrounding unimproved/improved roads (j) High-tension power lines and railroad tracks (k) Contour lines, township-range-section lines (l) Drainage patterns, swales, washes (m) All drainage conveyance/treatment structures (ditches, berms, etc.) (n) Any other pertinent or significant feature.

### Topographic Map

[NPDES Modification Map 2000 Scale.pdf - 02/09/2022 01:26 PM](#)

##### Comment

NONE PROVIDED

## Detailed Facility Map Submittal

### Detailed Facility Map

[NPDES Modification Map.pdf - 02/09/2022 02:17 PM](#)

##### Comment

NONE PROVIDED

## Outfalls (1 of 8)

Outfall Identifier: 001

**Feature Type**  
Outfall (External)

**Outfall Identifier**  
001

**Outfall Status**  
Existing

**Permit Action**  
Reissue

**Receiving Water**  
Mill Branch

**Check below if the discharge enters the receiving water via an unnamed tributary.**  
Unnamed Tributary

**Location of Outfall**  
34.15805600000000, -86.45222200000001

**Distance to Receiving Water (ft)**  
1,065

**Disturbed Area (acres)**  
18.8

**Drainage Area (acres)**  
18.8

**303(d) Segment?**  
No

**TMDL Segment?**  
No

### **Outfalls (2 of 8)**

**Outfall Identifier: 002**

**Feature Type**  
Outfall (External)

**Outfall Identifier**  
002

**Outfall Status**  
Existing

**Permit Action**  
Reissue

**Receiving Water**  
Mill Branch

**Check below if the discharge enters the receiving water via an unnamed tributary.**  
Unnamed Tributary

**Location of Outfall**  
34.15861100000000, -86.44972199999999

**Distance to Receiving Water (ft)**  
500

**Disturbed Area (acres)**

13.5

**Drainage Area (acres)**

27.4

**303(d) Segment?**

No

**TMDL Segment?**

No

**Outfalls (3 of 8)**

**Outfall Identifier: 003**

**Feature Type**

Outfall (External)

**Outfall Identifier**

003

**Outfall Status**

Proposed

**Permit Action**

Add

**Receiving Water**

Mill Branch

**Check below if the discharge enters the receiving water via an unnamed tributary.**

Unnamed Tributary

**Location of Outfall**

34.1615,-86.4465

**Distance to Receiving Water (ft)**

1,290

**Disturbed Area (acres)**

88

**Drainage Area (acres)**

88

**303(d) Segment?**

No

**TMDL Segment?**

No

**Outfalls (4 of 8)**

**Outfall Identifier: 004**

**Feature Type**

Outfall (External)

**Outfall Identifier**

004

**Outfall Status**

Proposed

**Permit Action**

Add

**Receiving Water**

Mill Branch

**Check below if the discharge enters the receiving water via an unnamed tributary.**

NONE PROVIDED

**Location of Outfall**

34.1681,-86.4465

**Distance to Receiving Water (ft)**

2,490

**Disturbed Area (acres)**

33

**Drainage Area (acres)**

33

**303(d) Segment?**

No

**TMDL Segment?**

No

**Outfalls (5 of 8)**

**Outfall Identifier: 005**

**Feature Type**

Outfall (External)

**Outfall Identifier**

005

**Outfall Status**

Proposed

**Permit Action**

Add

**Receiving Water**

Mill Branch

**Check below if the discharge enters the receiving water via an unnamed tributary.**

NONE PROVIDED

**Location of Outfall**

34.1691,-86.4438

**Distance to Receiving Water (ft)**

1,860

**Disturbed Area (acres)**

37

**Drainage Area (acres)**

37

**303(d) Segment?**

No

**TMDL Segment?**

No

**Outfalls (6 of 8)**

**Outfall Identifier: 006**

**Feature Type**

Outfall (External)

**Outfall Identifier**

006

**Outfall Status**

Proposed

**Permit Action**

Add

**Receiving Water**

Big Spring Creek

**Check below if the discharge enters the receiving water via an unnamed tributary.**

Unnamed Tributary

**Location of Outfall**

34.1728,-86.4497

**Distance to Receiving Water (ft)**

0

**Disturbed Area (acres)**

44

**Drainage Area (acres)**

47

**303(d) Segment?**

No

**TMDL Segment?**

No

**Outfalls (7 of 8)**

**Outfall Identifier: 007**

**Feature Type**

Outfall (External)

**Outfall Identifier**

007

**Outfall Status**

Proposed

**Permit Action**

Add

**Receiving Water**

Big Spring Creek

**Check below if the discharge enters the receiving water via an unnamed tributary.**

Unnamed Tributary

**Location of Outfall**

34.1681,-86.4554

**Distance to Receiving Water (ft)**

760

**Disturbed Area (acres)**

63

**Drainage Area (acres)**

66

**303(d) Segment?**

No

**TMDL Segment?**

No

**Outfalls (8 of 8)**

**Outfall Identifier: 008**

**Feature Type**

Outfall (External)

**Outfall Identifier**

008

**Outfall Status**

Proposed

**Permit Action**

Add

**Receiving Water**

Big Spring Creek

**Check below if the discharge enters the receiving water via an unnamed tributary.**

Unnamed Tributary

**Location of Outfall**

34.1604,-86.4582

**Distance to Receiving Water (ft)**

1,485

**Disturbed Area (acres)**

31

**Drainage Area (acres)**

31



303(d) Segment?

No

TMDL Segment?

No

### Discharge Characterization

#### **EPA Form 2C, EPA Form 2D, and/or ADEM Form 567 Submittal**

Yes, pursuant to 40 CFR 122.21, the applicant requests a waiver for completion of EPA Form 2C, EPA Form 2D, and ADEM Form 567 and certifies that the operating facility will discharge treated stormwater only; that chemical/compound additives are not used (unless waived in writing by the Department on a programmatic, categorical, or individual compound/chemical basis); that there are no process, manufacturing, or other industrial operations or wastewaters, including but not limited to lime or cement production and synfuel operations; and that coal and coal products are not mined nor stored onsite.

Please download the following Excel file to enter your information. Once complete, please attach to the below control.

[Download spreadsheet here.](#)

#### **Required attachment:**

[Discharge Characterization.pdf - 02/09/2022 03:32 PM](#)

#### **Comment**

NONE PROVIDED

Please download the following Excel file to enter your information. Once complete, please attach to the below control.

[Download spreadsheet here.](#)

#### **Required attachment:**

[Form315TableC.pdf - 02/09/2022 03:34 PM](#)

#### **Comment**

NONE PROVIDED

### Discharge Structure Description & Pollutant Source

Please download the following Excel file to enter your information. Once complete, please attach to the below control.

[Download spreadsheet here.](#)

#### **Required attachment:**

[Discharge Structure.pdf - 02/09/2022 03:53 PM](#)

#### **Comment**

NONE PROVIDED

### Variance Request

Do you intend to request or renew one or more of the CWA technology variances authorized at 40 CFR 122.21(m)?

No

### Pollution Abatement & Prevention (PAP) Plan Summary (1 of 1)

#### **Outfall(s):**

All Outfalls

Outfall Questions:	Please select one:
Runoff from all areas of disturbance is controlled	Yes
Drainage from pit area, stockpiles, and spoil areas directed to a sedimentation pond	Yes
Sedimentation basin at least 0.25 acre/feet for every acre of disturbed drainage	Yes
Sedimentation basin cleaned out when sediment accumulation is 60% of design capacity	Yes
Trees, boulders, and other obstructions removed from pond during initial construction	Yes

Outfall Questions:	Please select one:
Width of top of dam greater than 12'	Yes
Side slopes of dam no steeper than 3:1	Yes
Cutoff trench at least 8' wide	Yes
Side slopes of cutoff trench no less than 1:1	Yes
Cutoff trench located along the centerline of the dam	Yes
Cutoff trench extends at least 2' into bedrock or impervious soil	Yes
Cutoff trench filled with impervious material	Yes
Embankments and cutoff trench 95% compaction standard proctor ASTM	Yes
Embankment free of roots, tree debris, stones >6" diameter, etc.	Yes
Embankment constructed in lifts no greater than 12"	Yes
Spillpipe sized to carry peak flow from a one year storm event	Yes
Spillpipe will not chemically react with effluent	Yes
Subsurface withdrawal	Yes
Anti-seep collars extend radially at least 2' from each joint in spillpipe	Yes
Splashpad at the end of the spillpipe	Yes
Emergency Spillway sized for peak flow from 25-yr 24-hr event if discharge not into PWS classified stream	Yes
Emergency spillway sized for peak flow from 50-yr 24-hr event if discharge is into PWS classified stream	N/A
Emergency overflow at least 20' long	Yes
Side slopes of emergency spillway no steeper than 2:1	Yes
Emergency spillway lined with riprap or concrete	Yes
Minimum of 1.5' of freeboard between normal overflow and emergency overflow	Yes
Minimum of 1.5' of freeboard between max. design flow of emergency spillway and top of dam	Yes
All emergency overflows are sized to handle entire drainage area for ponds in series	Yes
Dam stabilized with permanent vegetation	Yes
Sustained grade of haul road <10%	Yes
Maximum grade of haul road <15% for no more than 300'	Yes
Outer slopes of haul road no steeper than 2:1	Yes
Outer slopes of haul road vegetated or otherwise stabilized	Yes
Detail drawings supplied for all stream crossings	N/A
Short-Term Stabilization/Grading And Temporary Vegetative Cover Plans	Yes
Long-Term Stabilization/Grading And Permanent Reclamation or Water Quality Remediation Plans	Yes

Identify and provide detailed explanation for any **N** or **N/A** response(s):

No discharges into a public water supply.  
No stream crossings are proposed.

### Pollution Abatement & Prevention (PAP) Plan Review Checklist

General Information:	Please select one:
PE Seal with License #	Yes
Name and Address of Operator	Yes
Legal Description of Facility	Yes
Name of Company	Yes
Number of Employees	Yes

General Information:	Please select one:
Products to be Mined	Yes
Hours of Operation	Yes
Water Supply and Disposition	Yes

Maps:	Please select one:
Topographic Map including Information from Part XIII (a) (o) of this Application	Yes
1 500 or Equivalent Facility Map including Information from Part XIV of this Application	Yes

Detailed Design Diagrams:	Please select one:
Plan Views	Yes
Cross-section Views	Yes
Method of Diverting Runoff to Treatment Basins	Yes
Line Drawing of Water Flow through Facility with Water Balance or Pictorial Description of Water Flow	Yes

Narrative of Operations:	Please select one:
Raw Materials Defined	Yes
Processes Defined	Yes
Products Defined	Yes

Schematic Diagram:	Please select one:
Points of Waste Origin	Yes
Collection System	Yes
Disposal System	Yes

Post Treatment Quantity and Quality of Effluent:	Please select one:
Flow	Yes
Suspended Solids	Yes
Iron Concentration	Yes
pH	Yes

Description of Waste Treatment Facility:	Please select one:
Pre-Treatment Measures	Yes
Recovery System	Yes
Expected Life of Treatment Basin	Yes
Measures for Ensuring Access to All Treatment Structures and Related Appurtenances including Outfall Locations	Yes
Schedule of Cleaning and/or Abandonment	Yes

Other:	Please select one:
Precipitation/Volume Calculations/Diagram Attached	Yes
BMP Plan for Haul Roads	Yes
Measures for Minimizing Impacts to Adjacent Stream (e.g., Buffer Strips, Berms)	Yes
Measures for Ensuring Appropriate Setbacks are Maintained at All Times	Yes
Methods for Minimizing Nonpoint Source Discharges	Yes
If Chemical Treatment Used, Methods for Ensuring Appropriate Dosage	Yes
Facility Closure Plans	Yes

<b>Other:</b>	<b>Please select one:</b>
PE Rationale(s) For Alternate Standards, Designs or Plans	No

Identify and provide detailed explanation for any **N** or **N/A** response(s):  
 No alternate standards, designs or plans are proposed.

### Pollution Abatement & Prevention (PAP) Plan

Is this a coal mining operation regulated by ASMC?  
 No

**PAP Plan (non-coal mining facilities)**

[Brooksville Sand Quarry PAP.pdf - 06/15/2022 09:37 AM](#)

**Comment**  
 NONE PROVIDED

**CORRECTION REQUEST (CORRECTED)**  
**PAP Follow up Information**

1. PAP Plan needs to reference an 50 ft. setback from streams and property lines. Also, how it will marked off so workers are aware not to mine within the 50 ft. 2. Previously submitted PAP Plan noted that the facility uses aglime and quicklime. Why is that missing from the PAP Plan? I've attached a copy of that page.  
 Created on 5/5/2022 12:28 PM by **Clint Dear**

**1 COMMENT**  
**Jonathan Whitlock (jwhitlock@mcgehee.org) (6/15/2022 9:37 AM)**  
 The corrections have been made as requested.

### Professional Engineer (PE)

Registration License Number  
 33277

**Professional Engineer**

**Prefix**  
*Mr.*

**First Name    Last Name**  
 Bradley        Simmons

**Title**  
*Professional Engineer*

**Organization Name**  
*McGehee Engineering Corp.*

**Phone Type    Number        Extension**  
 Business        2052210686

**Email**  
 bsimmons@mcgehee.org

**Address**  
 450 19th St West  
 Jasper, AL 35501-\_\_\_\_

### Information for the Applicant

**Please read the following information and acknowledge below:**  
 Contact the Department prior to submittal with any questions or to request acceptable alternate content/format.

Be advised that you are not authorized to commence regulated activity until this application can be processed, publicly noticed, and approval to proceed is received in writing from the Department.

EPA Form(s) 1 and 2F need not be submitted unless specifically required by the Department. EPA Form(s) 2C and/or 2D are required to be submitted unless the applicant is eligible for a waiver and the Department grants a waiver, or unless the relevant information required by EPA Form(s) 2C and/or 2D are submitted to the Department in an alternative format acceptable to the Department.

Planned/proposed mining sites that are greater than 5 acres, that mine/process coal or metallic mineral/ore, or that have wet or chemical processing, must apply for and obtain coverage under an Individual or General NPDES Permit prior to commencement of any land disturbance. Such Individual NPDES Permit coverage may be requested via this ADEM Form 315.

The applicant is advised to contact:

- (1) The Alabama Surface Mining Commission (ASMC) if coal, coal fines, coal refuse, or other coal related materials are mined, transloaded, processed, etc.;
- (2) The Alabama Department of Labor (ADOL) if conducting non-coal mining operations;
- (3) The Alabama Historical Commission for requirements related to any potential historic or culturally significant sites;
- (4) The Alabama Department of Conservation and Natural Resources (ADCNR) for requirements related to potential presence of threatened/endangered species;
- (5) The US Army Corps of Engineers, Mobile or Nashville Districts, if this project could cause fill to be placed in federal waters or could interfere with navigation.

The Department must be in receipt of a completed version of this form, including any supporting documentation, and the appropriate processing fee [including Greenfield Fee and Biomonitoring & Toxicity Limits fee(s), if applicable], prior to development of a draft NPDES permit.

#### Acknowledgement

I acknowledge I have read and understand the information above.

### Additional Attachments

#### Additional Attachments

NONE PROVIDED

#### Comment

NONE PROVIDED

### Application Preparer

#### Application Preparer

##### Prefix

*Mr.*

##### First Name      Last Name

Jonathan      *Whitlock*

##### Title

*Project Manager*

##### Organization Name

*McGehee Engineering Corp.*

##### Phone Type      Number      Extension

Business      205-221-0686

##### Email

*jwhitlock@mcgehee.org*

##### Address

450 19th St West

Jasper, Alabama 35501

### Fees Assessed

The following itemized fees have been assessed in accordance with Fee Schedule D and 335-1-6-.04(a) of ADEM Admin. Code Division 1 regulations based on the information provided in this application.

If the correct fees are not displayed, please contact your permit engineer PRIOR to submitting the form. Do NOT answer questions erroneously in order to have the correct fee assessed.

**Wet Preparation, Processing, Beneficiation:**  
6860

**Fee**

Fee  
6860

**Revisions**

---

Revision	Revision Date	Revision By
Revision 1	2/8/2022 1:23 PM	Jonathan Whitlock
Revision 2	6/13/2022 8:42 AM	Jonathan Whitlock

# Agreements and Signature(s)

## SUBMISSION AGREEMENTS

- I am the owner of the account used to perform the electronic submission and signature.
- I have the authority to submit the data on behalf of the facility I am representing.
- I agree that providing the account credentials to sign the submission document constitutes an electronic signature equivalent to my written signature.
- I have reviewed the electronic form being submitted in its entirety, and agree to the validity and accuracy of the information contained within it to the best of my knowledge.

## Professional Engineer (PE)

*A detailed, comprehensive Pollution Abatement & Prevention (PAP) Plan must be prepared, signed, and certified by a professional engineer (PE), registered in the State of Alabama, and the PE must certify as follows: I certify under penalty of law that the technical information and data contained in this application, and a comprehensive Pollution Abatement & Prevention (PAP) Plan, including any attached SPCC plan, maps, engineering designs, etc. acceptable to ADEM, for the prevention and minimization of all sources of pollution in stormwater and authorized related process wastewater runoff has been prepared under my supervision for this facility utilizing effective, good engineering and pollution control practices and in accordance with the provisions of this Permit, and ADEM Admin. Code Division 335-6, including Chapter 335-6-9 and Appendices A & B. If the PAP Plan is properly implemented and maintained by the Permittee, discharges of pollutants can reasonably be expected to be effectively minimized to the maximum extent practicable and according to permit discharge limitations and other permit requirements. The applicant has been advised that appropriate pollution abatement/prevention facilities and structural & nonstructural management practices or Department approved equivalent management practices as detailed in the PAP Plan must be fully implemented and regularly maintained as needed at the facility in accordance with good sediment, erosion, and other pollution control practices, permit requirements, and other ADEM requirements to ensure protection of groundwater and surface water quality.*

**Signed By** Bradley Simmons on 06/24/2022 at 3:18 PM

## Responsible Official

*This application must be signed and initialed by a Responsible Official of the applicant pursuant to ADEM Admin. Code Rule 335-6-6-.09 who has overall responsibility for the operation of the facility. I certify under penalty of law that this document, including technical information and data, the PAP Plan, including any SPCC plan, maps, engineering designs, and all other attachments were prepared under my direction or supervision in accordance with a system designed to assure that qualified personnel properly gathered and evaluated the information submitted. Based on my inquiry of the PE and other person or persons under my supervision who manage the system or those persons directly responsible for gathering the information, the information submitted is, to the best of my knowledge and belief, true, accurate, and complete. I am aware that there are significant penalties for submitting false information including the possibility of fine or imprisonment for knowing violations. A comprehensive PAP Plan to prevent and minimize discharges of pollution to the maximum extent practicable has been prepared at my direction by a PE for this facility utilizing effective, good engineering and pollution control practices and in accordance with the provisions of ADEM Admin. Code Division 335-6, including Chapter 335-6-9 and Appendices A & B, and information contained in this application, including any attachments. I understand that regular inspections must be performed by, or under the direct supervision of, a PE and all appropriate pollution abatement/prevention facilities and structural & nonstructural management practices or Department approved equivalent management practices identified by the PE must be fully implemented prior to and concurrent with commencement of regulated activities and regularly maintained as needed at the facility in accordance with good sediment, erosion, and other pollution control practices and ADEM requirements. I understand that the PAP Plan must be fully implemented and regularly maintained so that discharges of pollutants can reasonably be expected to be effectively minimized to the maximum extent practicable and according to permit discharge limitations and other requirements to ensure protection of groundwater and surface water quality. I understand that failure to fully implement and regularly maintain required management practices for the protection of groundwater and surface water quality may subject the Permittee to appropriate enforcement action. I certify that this form has not been altered, and if copied or reproduced, is consistent in format and identical in content to the ADEM approved form. I further certify that the discharges described in this application have been tested or evaluated for the presence of non-stormwater discharges and any non-mining associated beneficiation/process pollutants and wastewaters have been fully identified. I acknowledge my understanding that I may be required to obtain a permit from the ADOL. I acknowledge my understanding that if the proposed activities will be conducted in or potentially impact waters of the state or waters of the US (including wetlands), that I may be required to obtain a permit from the USACE.*

**Signed By** Frank Reed on 06/24/2022 at 3:11 PM









# Attachment 1 to Supplementary Form ADEM Form 311

## *Alternatives Analysis*

*Applicant/Project:* Whitaker Contracting Corp. - Brooksville Sand Quarry

All new or expanded discharges (except discharges eligible for coverage under general permits) covered by the NPDES permitting program are subject to the provisions of ADEM's antidegradation policy. Applicants for such discharges to Tier 2 waters are required to demonstrate "... that the proposed discharge is necessary for important economic or social development." As a part of this demonstration, the applicant must complete an evaluation of the discharge alternatives listed below, including a calculation of the total annualized project costs for each technically feasible alternative (using ADEM Form 312 for public-sector projects and ADEM Form 313 for private-sector projects). Alternatives with total annualized project costs that are less than 110% of the total annualized project costs for the Tier 2 discharge proposal are considered viable alternatives.

Alternative	Viable	Non-Viable	Comment
1 Land Application		X	Water quantity to great
2 Pretreatment/Discharge to POTW		X	Water quantity to great
3 Relocation of Discharge		X	Topography does not support/allow this alternative
4 Reuse/Recycle	X		Will recycle whenever possible
5 Process/Treatment Alternatives		X	Settling, oxidation, surface discharge best treatment alternative
6 On-site/Sub-surface Disposal	X		
<i>(other project-specific alternatives considered by the applicant; attach additional sheets if necessary)</i>			
7			
8			
9			

Pursuant to ADEM Administrative Code Rule 335-6-3-.04, I certify on behalf of the applicant that I have completed an evaluation of the discharge alternatives identified above, and reached the conclusions indicated.

Signature: *[Handwritten Signature]*  
(Professional Engineer)

Date: 2/9/22

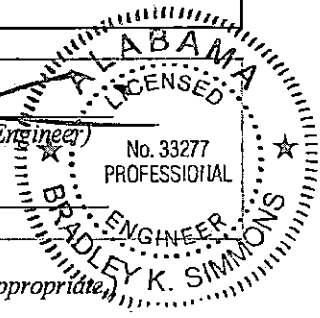

*(Supporting documentation to be attached, referenced, or otherwise handled as appropriate.)*

**Calculation of Total Annualized Project Costs  
for Private-Sector Projects**



Capital Costs to be Financed (Supplied by applicant)	<u>\$ 400,000 (1)</u>
Interest rate for Financing (Expressed as a decimal)	<u>.10 (i)</u>
Time Period of Financing (Assume 10 years*)	<u>10 years (n)</u>
Annualization Factor = $\frac{i}{(1+i)^{10} - 1} + i$	<u>0.16275 (2)</u>
Annualized Capital Cost [Calculate: (1) x (2) ]	<u>\$ 65,100 (3)</u>
Annual Cost of Operation and Maintenance (including but not limited to monitoring, inspection, permitting fees, waste disposal charges, repair, administration and replacement)**	<u>\$ 100,000 (4)</u>
<b>Total Annual Cost of Pollution Control Project [ (3) + (4) ]</b>	<b>\$ 165,100 (5)</b>

\* While actual payback schedules may differ across projects and companies, assume equal annual payments over a 10-year period for consistency in comparing projects.

\*\* For recurring costs that occur less frequently than once a year, pro rate the cost over the relevant number of years (e.g., for pumps replaced once every three years, include one-third of the cost in each year).

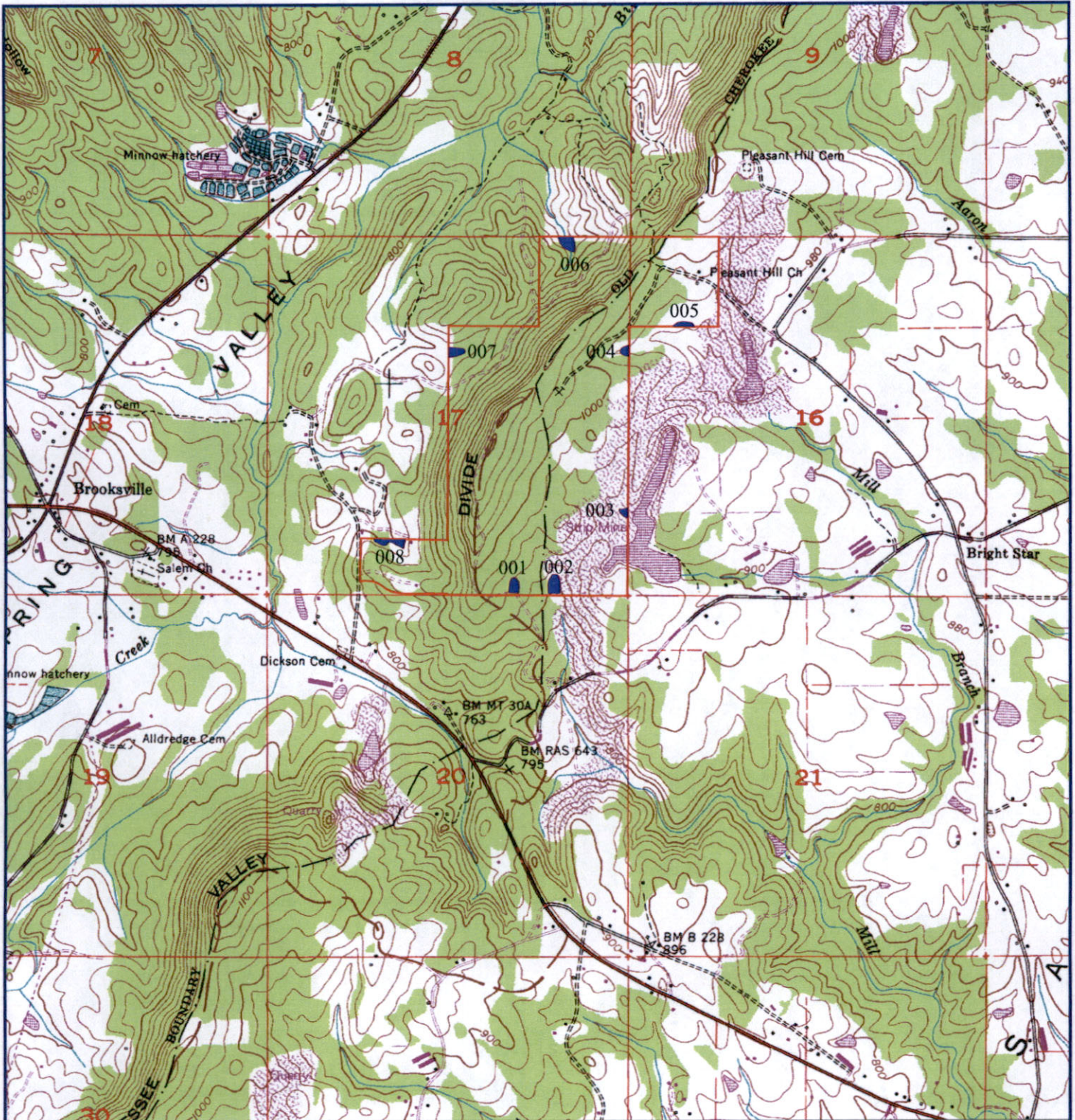



-  NPDES PERMIT BOUNDARY
-  NPDES OUTFALL

PORTIONS OF SECTIONS 16 & 17  
TOWNSHIP 2 SOUTH, RANGE 10 EAST,  
ALL IN BLOUNT COUNTY, ALABAMA

**WHITAKER CONTRACTING  
CORP.**

**BROOKSVILLE SAND QUARRY  
NPDES PERMIT MAP**

FILE: BROOKSVILLE	SCALE: 1" = 2000'	JOB NO: N/A	
DRAWN BY: B.K.S.	DATE: 02/08/2022	SHEET NO.: 1 OF 1	

**MEC**  
mcghee engineering corp  
post office box 3431 - 450 19th street  
jasper, alabama 35902-3431  
telephone: (205) 221-0686 fax: 221-7721  
email: staff@mcghee.org





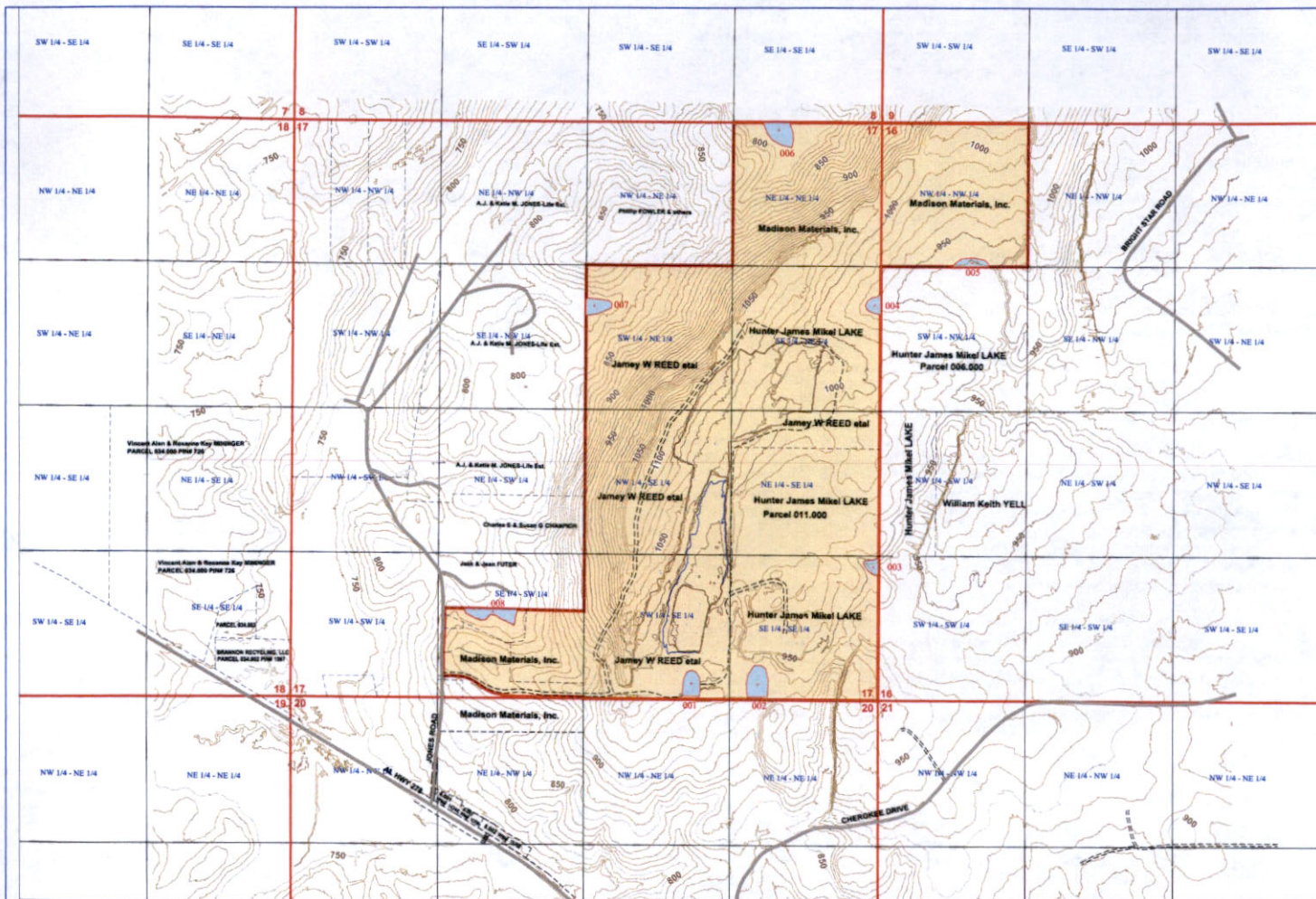

SCALE: 1" = 2 MILES

**MAP LEGEND**

- NPDES BOUNDARY
- PREVIOUSLY DISTURBED AREA
- SURFACE OWNERSHIP DIVIDE OTHER THAN QUARTER/QUARTER LINE
- MINERAL OWNERSHIP DIVIDE OTHER THAN QUARTER/QUARTER LINE
- SURFACE OWNERSHIP
- MINERAL OWNERSHIP
- FEE OWNERSHIP (SURFACE & MINERAL)
- EXISTING HIGHWALL
- PRIMARY HAULROAD
- ANCILLARY ROAD
- OCCUPIED DWELLING
- DRAINAGE COURSE
- DRAINAGE DIVIDE
- POWER TRANSMISSION LINE
- DIVERSION DITCH
- TOPSOIL STOCKPILE
- COAL STOCKPILE
- UNDERGROUND MINE OPENING
- SEDIMENT BASIN
- IMPOUNDED WATER
- LAND HOOK



SECTIONS 16 & 17,  
TOWNSHIP 19 SOUTH, RANGE 2 EAST,  
BLOUNT COUNTY, ALABAMA  
BASE MAPS: BROOKSVILLE  
U.S.G.S. QUADRANGLE  
CONTOUR INTERVAL: 10 FT. & 20 FT.

WHITAKER CONTRACTING CORP.

BROOKSVILLE SAND QUARRY  
NPDES PERMIT MAP

PROJECT: BROOKSVILLE	SCALE: 1" = 200'	JOB NO.:
APPROVED BY: B.M.S.	DATE: 03-04-22	SHEET: 1 OF 1



**Whitaker Contracting Corp.  
Brooksville Sand Quarry  
Pollution Abatement Plan**

## **POLLUTION ABATEMENT PLAN**

Prepared for:

Alabama Department of Environmental Management

**Whitaker Contracting Corp.**

Brooksville Sand Quarry

NPDES Permit Application

Prepared by:

**MCGEHEE ENGINEERING CORP.**

P. O. Box 3431

Jasper, Alabama 35502-3431

Telephone: (205) 221-0686

Fax: (205) 221-7721

Email: [cw@mcgehee.org](mailto:cw@mcgehee.org)

**Whitaker Contracting Corp.  
Brooksville Sand Quarry  
Pollution Abatement Plan**

**INTRODUCTION**

This document is an application for a proposed N.P.D.E.S. Permit. Whitaker Contracting Corp., Brooksville Sand Quarry is located in Sections 16 & 17, Township 2 South, Range 10 East, Blount County, Alabama. This application was prepared in accordance with the rules and regulations of the Alabama Department of Environmental Management.

The "Pollution Abatement Plan" is presented in two parts, which include a brief narrative and the "Pollution Abatement Plan" both presented herein. The narrative is intended to address the format as outlined by the ADEM Water Division - Water Quality and Control Program, rules and regulations, as well as present the basis for the design as further detailed in the "Pollution Abatement Plan". The drawings as presented in the "Pollution Abatement Plan" were derived from rules and regulations from ADEM as well as from other generally accepted design data sources primarily from the U.S. Department of Agriculture Soil Conservation Service. Generally, the narrative will follow the outline of Chapter 6 - 9 - .03, Surface Mining Rules and Regulations from the ADEM rules and regulations.

**OPERATOR**

The operator of this sand mine is Whitaker Contracting Corp. which will have it's home office as follows:

Whitaker Contracting Corp.  
692 Convict Camp Road  
Guntersville, Alabama 35976



**Whitaker Contracting Corp.  
Brooksville Sand Quarry  
Pollution Abatement Plan**

**GENERAL INFORMATION**

Whitaker Contracting Corp. proposes to operate a sand mining facility. As part of these operations, the sand will be mined, loaded on trucks, and transported. All surface drainage will be drained into one of the eight proposed sedimentation ponds. Water from these basins will then be discharged into a UT to Mill Branch, Mill Branch or UT to Big Spring Creek.

**TOPOGRAPHIC MAP.**

Design plans submitted with this document provide an existing contour map as taken from the Brooksville U.S.G.S., 7 - 1/2 minute, Quadrangle. The map shows the layout of the sand mining facility, drainage patterns and proposed outfalls. All surface drainage from the mining area drains naturally into the sedimentation ponds, permitted outfalls 001 - 008.

**SETBACKS**

The mining operation will maintain a 50 ft setback zone from contiguous property owners and public roads. This 50ft setback will be flagged prior to disturbance.

**SURFACE WATER DIVERSIONS**

The enclosed topographic map shows the contour of the land and general drainage patterns. All disturbed surface drainage will gravity drain through the sediment basins.

In the event that diversion ditch construction is necessary, diversion ditches will be constructed in accordance with the "Attached Diversion Ditch Criteria".

**QUALITY AND CHARACTERISTICS OF WASTE PRODUCTS**

The only waste products produced at the sand mine will be silts from mining and processing operations. The silts will be trapped and settle when passing through the sediment basins. Each sediment basin will be cleaned out as needed to provide adequate sediment retention volume for incoming materials. The pH, total iron and manganese, because of the nature of the operation, should pose no problem and should remain in compliance with the N.P.D.E.S. parameter requirements.

There should be no problem with acid mine drainage at this facility due to the geology of the site. However, if this was to become an issue, aglime and quicklime will be added appropriately to the settling ponds. If quicklime is added, the amount and the pond pH, monitored for 24 hours after the addition, will be recorded. Aglime will be utilized if acid mine drainage becomes a chronic issue. This product will be spread in the drainage courses leading to the settling ponds.

**SOLID OR LIQUID WASTE DISPOSAL PLAN**

**Whitaker Contracting Corp.  
Brooksville Sand Quarry  
Pollution Abatement Plan**

The sediment basins will be cleaned out when the capacity of said basins reach sixty (60%) percent of their design capacity. The sediment basins will be cleaned out in an environmentally safe manner (loader, backhoe, etc.). Sediment removed from the sediment basins will be disposed of in the pit excavated by mining. With the amount of marketable product being removed from the pit, enough volume for waste disposal will not be a problem.

### **SEDIMENT CONTROL FOR HAULROADS AND INCIDENTALS**

Haulroads, existing or created for this operation, will be ditched and stabilized by planting a grass mixture suitable for seasonal conditions, fertilizing and mulching all cut, fill, and borrow areas to minimize erosion and enhance re-stabilization. In small areas where incidental drainage cannot be diverted through the sediment basins, silt fences will be constructed to control runoff. Silt fences will be constructed in accordance with the attached "Silt Fence Design and Construction Specifications".

### **LOCATION OF ADJACENT STREAMS**

Included in the preceding N.P.D.E.S. Application is a map (Scale: 1" = 2000') showing the location of all adjacent streams and the receiving water of this operation. The mining operation will maintain a 50 ft setback zone around streams unless appropriately permitted by the Army Corp of Engineers. If the 50ft setback is needed, then the employees will be made aware and the setback will be flagged prior to disturbance.

### **NON-POINT SOURCE DISCHARGE CONTROL**

Because all disturbed areas are graded in such a manner as to route all drainage through the sediment basins, all drainage from the Brooksville Sand Quarry should carry all sediment (silts, clay, etc.) into the approved point source discharge outfalls. See the attached Sediment Basin Design Plans for Sediment Basins 001 – 008.

### **PUBLIC WATER SUPPLIES**

The receiving waters from the proposed sand and gravel mine are to the UT to Mill Branch, Mill Branch or UT to Big Spring Creek. These receiving streams are not a public water supply.

**APPENDIX A**

**SEDIMENT BASIN CONSTRUCTION SPECIFICATIONS**

## **SEDIMENT BASIN CONSTRUCTION SPECIFICATIONS**

Proposed sediment basins (temporary or permanent) will be designed and constructed using the following as minimum specifications:

### **1. EMBANKMENT REQUIREMENTS**

- A) The minimum width of the top of the embankment will under no circumstance be less than twelve (12) feet.
- B) The embankment will have a minimum front and back slope no steeper than 3 horizontal to 1 vertical.
- C) The foundation area of the embankment will be cleared and grubbed of all organic matter with no surface slope steeper than 1 horizontal to 1 vertical.
- D) A core will be constructed in a cutoff trench along the centerline of the embankment. The cutoff trench will be at least eight (8) feet wide with the side slope steepness to be no greater than 1 horizontal to 1 vertical. The material placed in the cutoff trench will be compacted to ninety-five (95%) percent of the standard proctor density, as set forth in ASTM.
- E) The embankment construction material will be free of sod, roots, stumps, rocks, etc., which exceed six (6") inches in diameter. The embankment material will be placed in layers of twelve (12") inches or less and compacted to ninety five (95%) percent of the standard proctor density, as set forth in ASTM.
- F) The embankment, foundation and abutments will be designed and constructed to be stable under normal construction and operating conditions, with a minimum static safety factor of 1.5 and a minimum seismic safety factor of 1.2, at normal pool level with steady seepage saturation conditions.
- G) The actual constructed height of the embankment will be a minimum of five (5%) percent higher than the design height to allow for settling over the life of the embankment.
- H) All basins will have a minimum of 1.5 feet of freeboard between the normal overflow and the emergency spillway and a minimum 1.5 feet of freeboard between the height of the maximum design flow and the top of the dam anticipated from a 25 Year - 24 Hour precipitation event.

**SEDIMENT BASIN CONSTRUCTION SPECIFICATIONS  
(continued)**

- I) For embankments constructed as point source discharges, the embankment will be constructed and abutments keyed into undisturbed, virgin, ground if at all possible. In the event that this cannot be achieved, additional design and construction specifications will be submitted in the Detailed Basin Design Plans.
- J) The embankment and all areas disturbed in the construction of the embankment will be seeded with a mixture of perennial and annual grasses, fertilized and mulched to prevent erosion and ensure re-stabilization. Hay dams, silt fences, and rock check dams, etc. will be installed, where deemed necessary, as additional erosion prevention methods.

**2. DISCHARGE STRUCTURE REQUIREMENTS**

- A) The primary spillway will be designed to adequately carry the anticipated peak runoff from a 25 Year - 24 Hour precipitation event. The combination primary and secondary (emergency) spillway system will be designed to safely carry the anticipated peak runoff from a 25 Year - 24 Hour precipitation event. When sediment basins are proposed in the drainage course of a public water supply, the spillway system will be designed and constructed to adequately carry the runoff from a 50 Year - 24 Hour precipitation event. The emergency spillway in the control section will be at least 20 feet in length; the side slopes will be no steeper than 2:1, and the percent slope from the entrance to the exit section of the emergency spillway will be no greater than that stated in the design plans.
- B) Channel linings, for single channel spillway systems, will be riprap or concrete.
- C) When consisting of pipe, the primary spillway will be installed according to Class "C" pipe installation for embankment bedding. Where exposed above ground along the backslope of the embankment, the pipe will have an anti-seep collar installed at each joint of the discharge pipe to radiate at least two (2) feet from the pipe in all directions.
- D) Sediment basins with a single spillway system, such as a skimmer board, will be a trapezoidal open channel constructed in consolidated, non-erodible material and lined with riprap, concrete, asphalt or durable rock.

**SEDIMENT BASIN CONSTRUCTION SPECIFICATIONS  
(continued)**

- E) The primary spillway will be designed and constructed with a device to eliminate floating solids from leaving the impoundment. This device will consist of a turned down elbow when using pipe or a skimmer system when using an open channel spillway.
- F) When necessary, to prevent erosion of the embankment or discharge area, a splash pad of riprap, durable rock, saccrete, etc. will be installed at the discharge end of the primary spillway.
- G) The combined spillway systems, for sediment basins constructed in series, will be designed to adequately accommodate the entire drainage area.

**3. INSPECTION, MAINTENANCE AND CERTIFICATION REQUIREMENTS**

- A) Inspections will be conducted regularly during construction of the sediment basin by a qualified registered professional engineer or other qualified person under the direction of a professional engineer. Upon completion of construction, the sediment basin will be certified, by a qualified registered professional engineer, to the Regulatory Authority as having been constructed in accordance with the approved detailed design plans.
- B) Sediment basins will be inspected semi-monthly for erosion, instability, etc., until the removal of the structure or an NPDES Permit is no longer required at this site.
- C) Sediment basins will be examined quarterly for structural weakness, instability, erosion, slope failure, or other hazardous conditions.
- D) If during the above described periodic inspections, it is determined that there exists signs of structural weakness, instability, erosion, slope failure, improper functioning, or other hazardous conditions, these will be repaired immediately.
- E) Standard anticipated maintenance will include repairing rills and gullies, repairing slope failures, re-seeding areas of failed or scarce vegetation, cleaning out or removing debris obstructing pipes and/or spillways to allow proper functioning, etc. Standard maintenance discovered during the above described periodic inspections will be performed immediately. Hazardous conditions observed during inspections will be reported immediately to the Regulatory Authority for further consultation or instructions.

**SEDIMENT BASIN CONSTRUCTION SPECIFICATIONS  
(continued)**

- F) Retained sediment will be removed from each sediment basin when the accumulated sediment reaches sixty (60%) percent of its design capacity.

**4. BASIN REMOVAL REQUIREMENTS**

- A) Upon completion of mining, reclamation, restabilization and effluent standards being met, the operator will submit to ADEM a request in writing to abandon, remove, or permanently leave the sediment basin(s) and measures that will be taken to comply with applicable ADEM regulations.
- B) Once the operator has received approval from ADEM, each sediment basin not proposed as a permanent water impoundment will be de-watered in a controlled manner by either pumping or siphoning. Upon successful dewatering, a determination will be made as to the retained sediment level in the basin. After determining the retained sediment level, a channel will be cut into the embankment down to the retained sediment level on the side of the embankment deemed most suitable to reach natural ground without encountering prohibiting rock. The embankment material removed from this newly constructed channel will be spread and compacted over the previous impoundment (wet area) area to prevent erosion and ensure re-stabilization. The newly constructed channel will be of adequate width (minimum 30 feet) and sloped to a grade (approximately 1% to 3%) which will cause all surface drainage to travel across this area in sheet flow, minimizing the possibility of erosion. Also, where necessary, hay dams will be installed in strategic locations across the width of the channel to retain sediment and slow the water velocity to a favorable rate. Upon removal of the embankment section, all disturbed areas will be graded in such a manner to ensure slope stability, successful re-stabilization and to minimize erosion. All disturbed areas will be seeded with a mixture of annual and perennial grasses fertilized and mulched. No slope, existing or created in the removal of the sediment basin, will be left on a grade that will slip or slough.

**5. PERMANENT WATER IMPOUNDMENT REQUIREMENTS**

- A) All sediment basins remaining as permanent water impoundments will have supplemental data submitted to the Regulatory Authority concerning water quality, water quantity, size, depth, configuration, postmining land use, etc.
- B) Final grading slopes of the entire permanent water impoundment area will not exceed a slope of 2 Horizontal to 1 Vertical to provide for safety and access for future water users.

**APPENDIX B**

**DIVERSION DITCH CONSTRUCTION SPECIFICATIONS**



**DIVERSION DITCH AND DIVERSION BERM  
DESIGN AND CONSTRUCTION SPECIFICATIONS**

- 1) Temporary diversions will be designed and constructed to adequately carry the runoff from a 2-Year - 6 Hour precipitation event.
- 2) Permanent diversions will be designed and constructed to adequately carry the runoff from a 10 Year - 6 Hour precipitation event.
- 3) Permanent diversions will be designed and constructed with gently sloping banks stabilized with appropriate vegetation.
- 4) All diversions will be designed, constructed and maintained, using the best technology currently available, whereas additional contribution of suspended solids to stream-flow and to runoff outside the permit area is prevented.
- 5) Maintenance of appropriate gradient, channel lining, revegetation, roughness structures, detention basins, etc. will be used, when necessary, as sediment control measures for these diversions.
- 6) Diversions will not be constructed on existing landslides nor be located so as to increase the potential for landslides.
- 7) Temporary diversions will be removed and the affected area regarded, topsoiled (if required) and revegetated when no longer needed.
- 8) Channel linings, for diversions with slopes of five (5%) percent or less, will consist of a mixture of both annual and perennial grasses being predominantly fescue and bermuda. Channel linings, for diversions with slopes greater than five (5%) percent, will consist of riprap or other non-erodible material or cut into non-erodible material.
- 9) Adequate freeboard will be provided for protection for transition of flows and critical areas such as swells and curves along the entire diversion length.
- 10) At discharge points, where diversions intersect with natural streams or exit velocities of the diversion are greater than that of the receiving streams, energy dissipaters will be installed when deemed necessary.

**DIVERSION DITCH AND DIVERSION BERM  
DESIGN AND CONSTRUCTION SPECIFICATIONS  
(continued)**

- 11) Excess material excavated in the construction of the diversion, not needed for diversion channel geometry or the re-grading of the channel; will be disposed of in the mining pit.
- 12) Diversions will not be designed or constructed to divert water into underground mines without written approval from the Regulatory Authority.
- 13) The entire area in which a diversion berm is proposed will be cleared and grubbed of all organic material, scarified, and no surface slopes will be left steeper than 1V:1H.
- 14) Diversion berms will be constructed with desirable material, free of sod, stones, roots, limbs, etc. over six (6") inches in diameter. This material will be spread in layers no greater than twelve (12") inches in thickness and compacted to ninety five (95%) percent of the standard proctor density, as outlined in ASTM, until the design height is reached.
- 15) Upon completion of construction of diversion ditches or diversion berms, all disturbed areas will be seeded with a mixture of both annual and perennial grasses, fertilized, and mulched in order to minimize erosion and ensure re-stabilization.
- 16) All diversions (berms or ditches) will be examined quarterly for erosion, instability, structural weakness, or other hazardous conditions and maintenance performed as necessary.

**APPENDIX C**

**SILT FENCE DESIGN AND CONSTRUCTION SPECIFICATIONS**

**SILT FENCE DESIGN AND  
CONSTRUCTION SPECIFICATIONS**

- 1) Mesh height - 3'0" including 6" trench flap.
- 1) Prefabricated with 4 1/2" long treated hardwood stakes spaced on 7'7" centers.
- 2) Mesh opening - Equivalent Opening Size (E.O.S.) by U.S. Standard sieve measure (ASTM D4751-87) is 20-30 mesh.
- 4) Allowable Flow Rate - 40 gallon per minute per square foot (Test Method CFMC GET-2).
- 5) Maximum Particle Size Passing - 0.595 millimeter.
- 6) Mullen Burst Strength - 210 pounds per square inch (ASTM D- 3786-80).
- 7) Grab Strength - 120 pounds per square inch.
- 8) Maximum Elongation - 30 percent (ASTM D-1682-64).
- 9) The silt fence will be installed by initially cutting a trench approximately six (6") inches wide by six (6") inches deep, along the contour for the entire length of the fence. Upon completion of the trench, the silt fence will be stretched along side the trench with the treated hardwood stakes being driven into the ground approximately two (2') feet deep against the upper wall of the trench. The six (6") inch trench flap will then be laid along the bottom of the trench and covered with compacted fill material. (See Attached Typical Section)
- 10) Prior to the removal of the silt fence, any silt or sediment retained by the silt fence will be seeded with a mixture of both annual and perennial grasses, fertilized and mulched.

**APPENDIX D**

**PRIMARY HAUL ROAD**

**DESIGN AND CONSTRUCTION SPECIFICATIONS**

**DESIGN, CONSTRUCTION, MAINTENANCE, AND  
RECLAMATION SPECIFICATIONS FOR PRIMARY ROADS**

**1. LOCATION**

- A) Primary roads will be located on ridges or high areas or on the most stable available slopes so as to control and prevent erosion, siltation, flooding, and adverse impacts to fish and wildlife, or their habitat and related environmental values, to the extent possible.
- B) No part of any primary road will be located in the channel of an intermittent or perennial stream without written approval from the Regulatory Authority.
- C) If at all possible, all primary roads will be located upstream of sediment basins to prevent, control and minimize additional contributions of suspended solids to stream flow or runoff outside the permit area, the violation of applicable State or Federal water quality standards, seriously altering the normal flow of water in stream-beds or drainage channels, and damage to all public or private property.
- D) In instances where it is not possible to locate primary roads in the above manner, sediment control will be achieved by the use of silt fences, rock check dams, hay bale berms, etc.

**2. DESIGN REQUIREMENTS**

- A) Primary roads will be designed by or under the direct supervision of a qualified registered Professional Engineer experienced in the design and construction of roads, in accordance with the ADEM rules and regulations, and current, prudent engineering practices. No Primary Road grade will be steeper than fifteen (15) percent.
- B) All primary roadway embankments will be designed and constructed to be stable under normal construction and operating conditions, with a minimum static safety factor of 1.3.
- C) All primary roads will be designed, constructed, reconstructed and maintained to have adequate drainage control structures to safely pass the peak runoff anticipated from a 10 year, 6 hour precipitation event.

### **3. CONSTRUCTION REQUIREMENTS**

- A) The foundation area of the roadbed will be cleared and grubbed of all organic material and the topsoil will be removed. The disturbed area will be kept to the minimum necessary to accommodate the roadbed and/or associated drainage ditch construction.
  
- B) The road construction material will be suitable subgrade material, free of sod, roots, stumps, etc., and will not contain rocks which exceed twelve (12) inches in diameter. The road construction material will be placed in layers (12 inch maximum thickness) and compacted to ninety five (95%) percent of the standard proctor density, as set forth in ASTM.
  
- C) The minimum top width of primary roads will under no circumstance be less than sixteen (16) feet and will be of maximum width necessary to facilitate the largest equipment using the road.
  
- D) All slopes (cut and fill) will be no steeper than 2 horizontal to 1 vertical, unless specified otherwise in the detailed design.
  
- E) Roadbeds will be cut into consolidated, non-erodible material or will be surfaced with durable, non-toxic, non-acid forming material. In most instances, durable sandstone overburden material from the mine site will be used for surfacing material. In instances where durable sandstone overburden material from the site is not available or suitable, then durable, non-toxic, non-acid forming material, such as chert, crushed limestone, redrock, and/or crushed sandstone will be hauled in from off site, placed and compacted on the roadbed surface a minimum depth of four (4) inches.
  
- F) Primary roads will be constructed with grades no steeper than fifteen (15) percent for no more than 300'.

### **4. DRAINAGE AND SEDIMENT CONTROL REQUIREMENTS**

- A) Primary roads will be constructed, reconstructed, and maintained to have adequate drainage control, using structures such as, but not limited to bridges, culverts, drainage pipes, ditches, cross drains, and ditch relief drains designed to safely pass the peak runoff anticipated from a 10 year, 6 hour precipitation event. All drainage control structures will be designed and constructed in such a manner whereas, to allow a free and operating conditions to prevent, control, and minimize erosion at the inlets and outlets.

**Whitaker Contracting Corp.**  
**Brooksville Sand Quarry**  
**Pollution Abatement Plan**

- A) Culverts and drainage pipes will be designed and installed to provide adequate support for the load of the largest equipment using the road. For design purposes, "H-20" (live load + impact) was used. All culverts or drainage pipes with diameters of forty-eight (48) inches or less will be covered with a minimum of one (1) foot and the maximum cover will not exceed fifty-seven (57) feet of desirable compacted material. All culverts or drainage pipes with diameters greater than forty-eight (48) inches will be covered with a minimum of two (2) feet and the maximum cover will not exceed forty-one (41) feet of desirable compacted material.
- B) Culverts and drainage pipes will be designed and installed to allow adequate freeboard to prevent overtopping of the embankment.
- C) Drainage ditches, cross drains, and ditch relief drains will be constructed and maintained to prevent uncontrolled surface drainage over the road surface and roadway embankment.
- F) Drainage ditches will be constructed with no sustained grades greater than five (5%) percent, unless unavoidable. If ditches must be constructed with grades in excess of five (5%) percent, drainage ditches will be lined with riprap.
- G) Sediment control will be achieved by the use of silt fences, rock check dams, hay bale berms, etc. in strategic locations, to prevent excessive siltation to the receiving streams.
- H) Upon completion of construction of all roads, the side slopes of the roadway cut and fill sections, including all borrow areas formed in the construction, areas used for disposal of excess material, ditches, etc. will be seeded with a mixture of perennial and annual grasses, fertilized and mulched to prevent erosion and ensure restabilization. Grass mixtures will include, but not be limited to, fescue, bermuda, rye grass, browntop millet, clover and sericea.

**5. INSPECTION AND MAINTENANCE REQUIREMENTS**

- A) Routine inspections and maintenance (such as re-grading, resurfacing, maintenance of sediment control structures, spot replanting, and dust control) will be conducted regularly during the life of each road to assure that each road continually meets design and performance standards.
- B) Dust control will be achieved by the periodic application of water, chemical binders and/or other dust suppressants.
- C) Any road damaged by a catastrophic event, such as a flood, or earthquake, will be repaired as soon as it is practicable after the damage has occurred.



## **6. CERTIFICATION REQUIREMENTS**

- A) Primary roads will be designed by or under the direct supervision of a qualified registered Professional Engineer experienced in the design and construction of roads, in accordance with the ADEM rules and regulations, and current, prudent engineering practices. Each design will be certified by a registered Professional Engineer as being designed in accordance with the Regulations of the ADEM.
- B) Upon the completion of the construction of each section of the primary road, as set forth in the detailed design plans, the construction will be certified by a registered Professional Engineer, to ADEM, as being constructed in accordance with these specifications.

## **7. REMOVAL AND RECLAMATION REQUIREMENTS**

- A) All primary roads that are not mined through and remain after the completion of mining may be left as permanent roads for landowner access, if there is no opposition by said landowner.
- B) All primary roads that are not mined through and remain after the completion of mining which are not to be retained as permanent for landowner access will be removed and reclaimed as soon as practicable after it is no longer needed for mining and reclamation purposes. This removal and reclamation will include:
  - 1. Closing the road to traffic.
  - 2. Removing all bridges, culverts, drainage pipes, and other drainage control structures, unless otherwise approved as part of the postmining land use.
  - 3. Removing and/or otherwise disposing of road surfacing materials, that are not compatible with the postmining land use and re-vegetation requirements, onsite or removed and stored for re-use.
  - 4. Reshaping and re-grading cut and fill slopes as necessary to be compatible with the postmining land use and to compliment the natural drainage pattern of the surrounding terrain.
  - 5. Protecting the natural drainage patterns by installing dikes or cross drains as necessary to control surface runoff and erosion.

**Whitaker Contracting Corp.  
Brooksville Sand Quarry  
Pollution Abatement Plan**

6. Scarifying or ripping the roadbed, replacing topsoil or substitute material, and revegetating the entire disturbed area.

**8. TYPICAL ROADBED CONFIGURATION**

- A) See attached drawings, cross-sections, etc., for an illustration of the typical roadbed configurations.

**APPENDIX E**

**PROPOSED SEDIMENT BASINS**

**CONSTRUCTION REQUIREMENTS**

Sediment Basins 001 & 002 were designed, constructed and certified by other qualified professional engineers.

### **SEDIMENT BASIN 003P**

Drainage Area: 88 Acres  
Disturbed Area: Initial 10 Acres, Final – 88 Acres  
Primary Spillway: 36" CMP  
Emergency Spillway: 24" CMP  
Sediment Volume: 1.50 Acre-Feet  
Detention Volume: 1.00 Acre-Feet  
Normal Pool Volume: 2.50 Acre-Feet

Sediment Basin 003P will be an incised basin. The pond area will be constructed by excavating an 150' x 150' x 5' area. The primary spillway for Basin 003P will be installed at the existing ground level with the emergency spillway at the same level as the primary spillway. As the active pit advances to Sediment Basin 003P, the pit area greatly enlarges due to the removal of decorative sand stone. Once the active pit advances to Sediment Basin 003P, a very large, completely incised Basin 003 will be created. The final configuration of Sediment Basin 003 will contain an enormous volume of sediment storage and detention volume.

### **SEDIMENT BASIN 004P**

Drainage Area: 33 Acres  
Disturbed Area: Initial 10 Acres, Final – 33 Acres  
Primary Spillway: 24" CMP  
Emergency Spillway: 24" CMP  
Sediment Volume: 1.50 Acre-Feet  
Detention Volume: 1.00 Acre-Feet  
Normal Pool Volume: 2.50 Acre-Feet

Sediment Basin 004P will be an incised basin. The pond area will be constructed by excavating an 150' x 150' x 5' area. The primary spillway for Basin 004P will be installed at the existing ground level with the emergency spillway at the same level as the primary spillway. As the active pit advances to Sediment Basin 004P, the pit area greatly enlarges due to the removal of decorative sand stone. Once the active pit advances to Sediment Basin 004P, a very large, completely incised Basin 004 will be created. The final configuration of Sediment Basin 004 will contain an enormous volume of sediment storage and detention volume.

### **SEDIMENT BASIN 005P**

Drainage Area: 37 Acres  
Disturbed Area: Initial 10 Acres, Final – 37 Acres  
Primary Spillway: 24” CMP  
Emergency Spillway: 24” CMP  
Sediment Volume: 1.50 Acre-Feet  
Detention Volume: 1.00 Acre-Feet  
Normal Pool Volume: 2.50 Acre-Feet

Sediment Basin 005P will be an incised basin. The pond area will be constructed by excavating an 150’ x 150’ x 5’ area. The primary spillway for Basin 005P will be installed at the existing ground level with the emergency spillway at the same level as the primary spillway. As the active pit advances to Sediment Basin 005P, the pit area greatly enlarges due to the removal of decorative sand stone. Once the active pit advances to Sediment Basin 005P, a very large, completely incised Basin 005 will be created. The final configuration of Sediment Basin 005 will contain an enormous volume of sediment storage and detention volume.

### **SEDIMENT BASIN 006P**

Drainage Area: 47 Acres  
Disturbed Area: Initial 10 Acres, Final – 47 Acres  
Primary Spillway: 24” CMP  
Emergency Spillway: 24” CMP  
Sediment Volume: 1.50 Acre-Feet  
Detention Volume: 1.00 Acre-Feet  
Normal Pool Volume: 2.50 Acre-Feet

Sediment Basin 006P will be an incised basin. The pond area will be constructed by excavating an 150’ x 150’ x 5’ area. The primary spillway for Basin 006P will be installed at the existing ground level with the emergency spillway at the same level as the primary spillway. As the active pit advances to Sediment Basin 006P, the pit area greatly enlarges due to the removal of decorative sand stone. Once the active pit advances to Sediment Basin 006P, a very large, completely incised Basin 006P will be created. The final configuration of Sediment Basin 006 will contain an enormous volume of sediment storage and detention volume.

### **SEDIMENT BASIN 007P**

Drainage Area: 66 Acres  
Disturbed Area: Initial 10 Acres, Final – 66 Acres  
Primary Spillway: 30” CMP  
Emergency Spillway: 24” CMP  
Sediment Volume: 1.50 Acre-Feet  
Detention Volume: 1.00 Acre-Feet  
Normal Pool Volume: 2.50 Acre-Feet

Sediment Basin 007P will be an incised basin. The pond area will be constructed by excavating an 150’ x 150’ x 5’ area. The primary spillway for Basin 007P will be installed at the existing ground level with the emergency spillway at the same level as the primary spillway. As the active pit advances to Sediment Basin 007P, the pit area greatly enlarges due to the removal of decorative sand stone. Once the active pit advances to Sediment Basin 007P, a very large, completely incised Basin 007P will be created. The final configuration of Sediment Basin 007 will contain an enormous volume of sediment storage and detention volume.

### **SEDIMENT BASIN 008P**

Drainage Area: 31 Acres  
Disturbed Area: Initial – 31 Acres  
Primary Spillway: 24” CMP  
Emergency Spillway: 24” CMP  
Sediment Volume: 1.50 Acre-Feet  
Detention Volume: 1.00 Acre-Feet  
Normal Pool Volume: 2.50 Acre-Feet

Sediment Basin 008P will be an incised basin. The pond area will be constructed by excavating an 150’ x 150’ x 5’ area. The primary spillway for Basin 008P will be installed at the existing ground level with the emergency spillway at the same level as the primary spillway. As the active pit advances to Sediment Basin 008P, the pit area greatly enlarges due to the removal of decorative sand stone. Once the active pit advances to Sediment Basin 008P, a very large, completely incised Basin 008P will be created. The final configuration of Sediment Basin 008 will contain an enormous volume of sediment storage and detention volume.

**Whitaker Contracting Corp.  
Brooksville Sand Quarry  
Pollution Abatement Plan**

**DESIGN CERTIFICATION STATEMENT**

I, C. W. McGehee, a qualified Registered Professional Engineer, hereby certify that the above "Pollution Abatement Plan" was developed under my direct supervision and is true and correct to the best of my knowledge and belief.

**MCGEHEE ENGINEERING CORP.**

  
C. W. McGehee, P.E.  
Alabama Reg. No. 17067

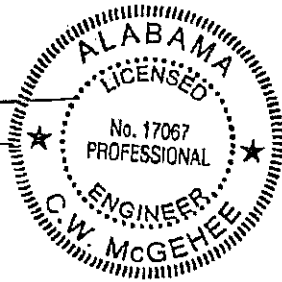

2-10-22  
Date



post office box 3431  
jasper, alabama 35502-3431  
telephone: (205) 221-0686 fax: 221-7721  
email: cw@mcgehee.org

### PLAN VIEW OF EMBANKMENT POND TYPICAL DRAWING

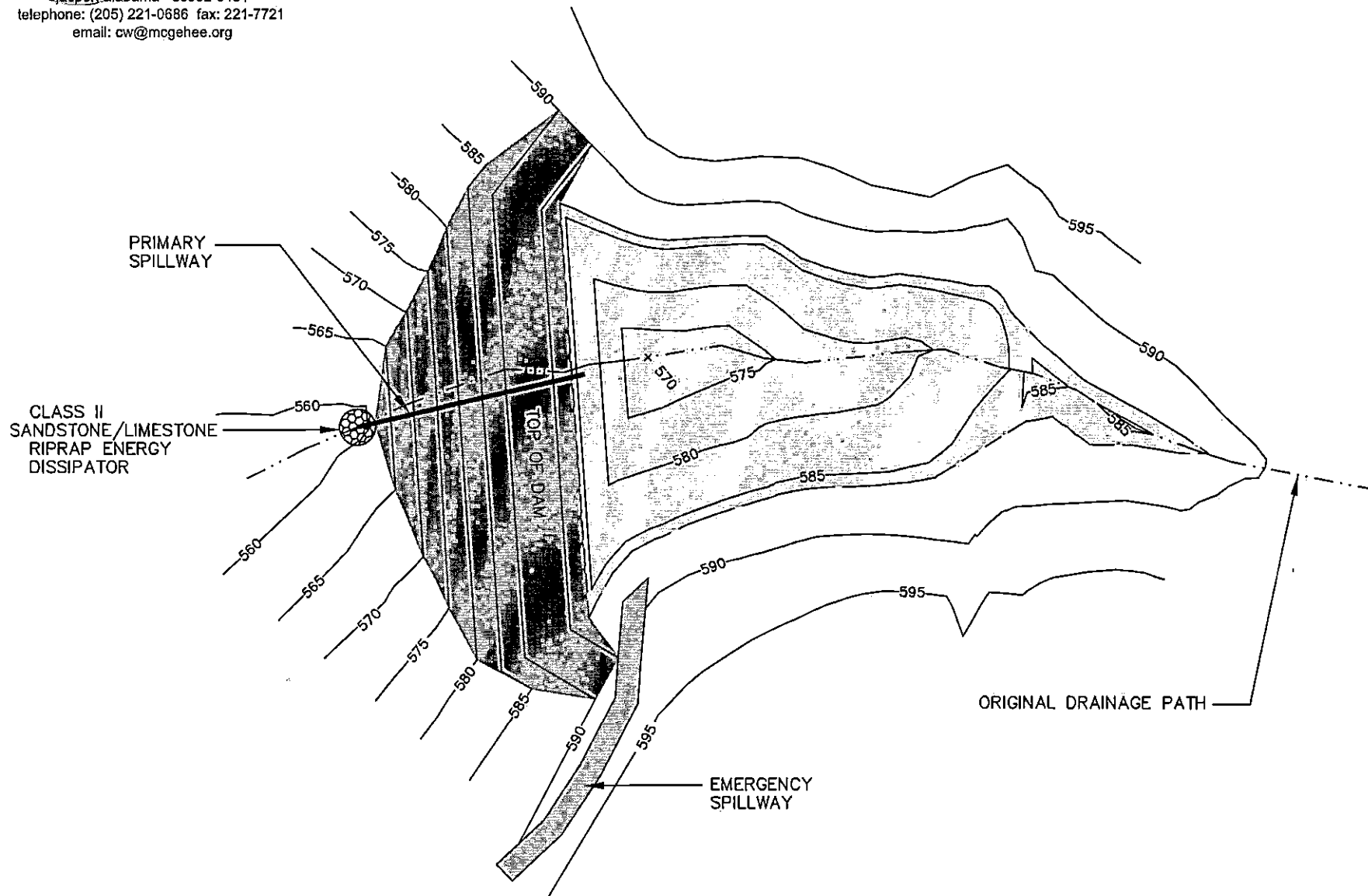



**TYPICAL EMBANKMENT CROSS-SECTION**

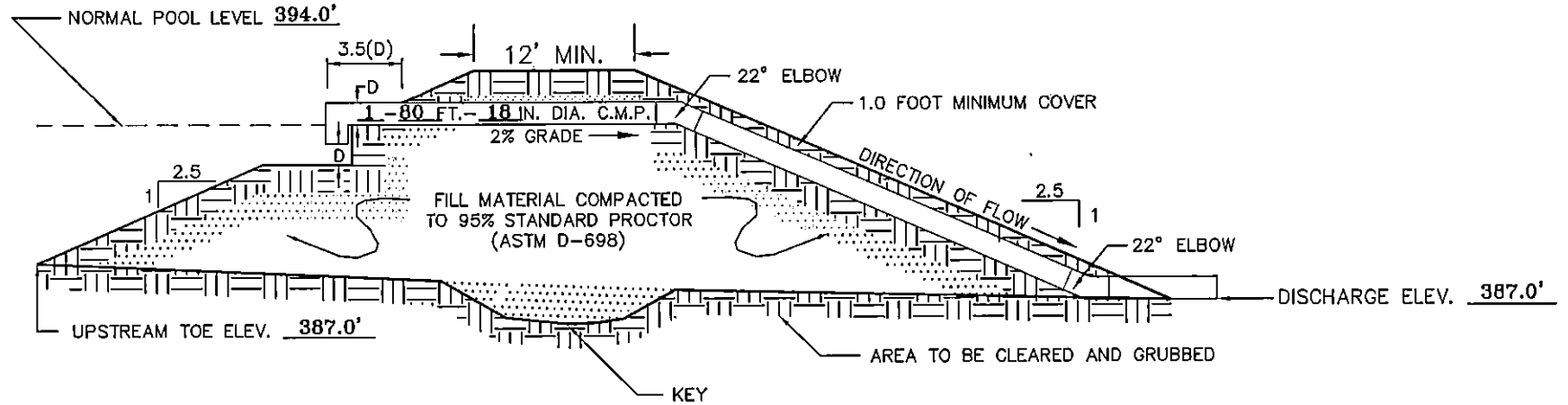

**TYPICAL IMPOUNDMENT PROFILE**

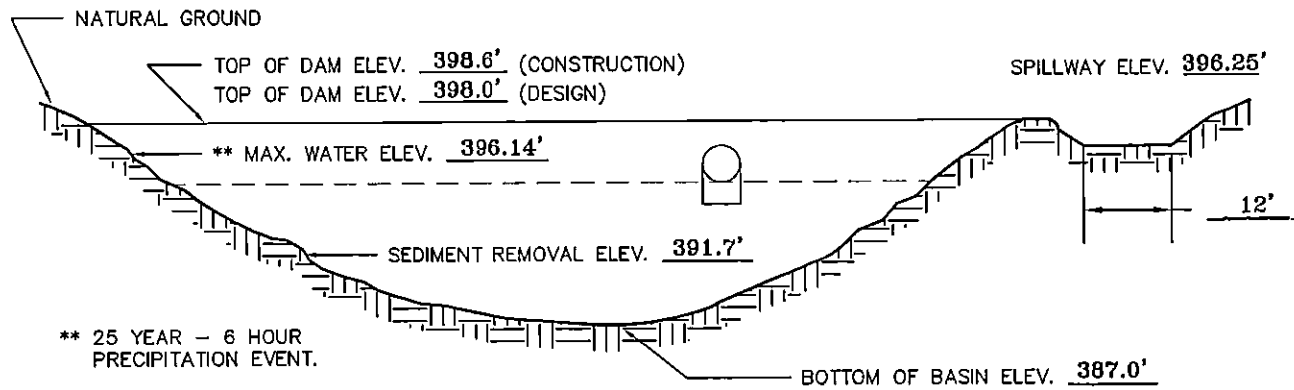

**PRIMARY ROAD  
TYPICAL CUT SECTION**

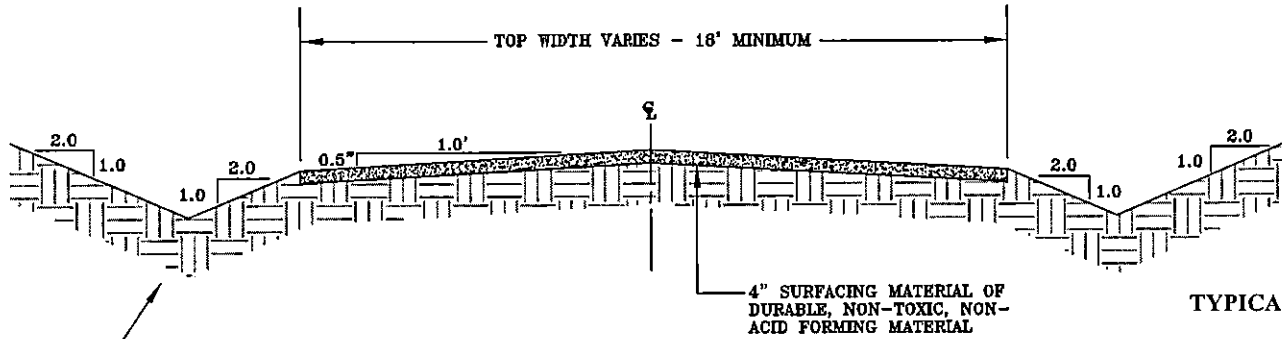

**PRIMARY ROAD  
TYPICAL DRAINAGE DITCH CROSS-SECTION**

MINIMUM DRY FREEBOARD: 0.5'  
MAXIMUM FLOW DEPTH: 2.0'

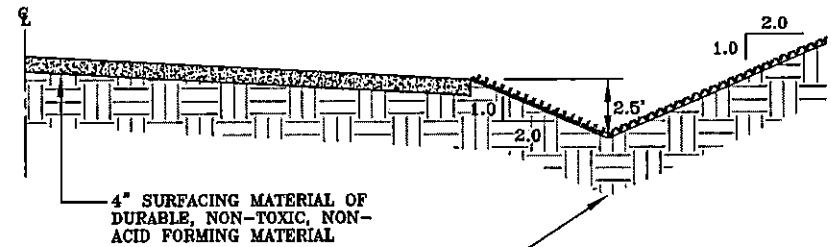

MINIMUM GRADIENT: 0.5%  
MAXIMUM GRADIENT: 10.0%

DRAINAGE DITCH TO BE LINED WITH GRASS MIXTURE.  
SEE SPECIFICATIONS. SEE DETAILED DESIGN PLANS FOR  
SPECIFIC DESIGN REQUIREMENTS.

**PRIMARY ROAD  
TYPICAL FILL SECTION**

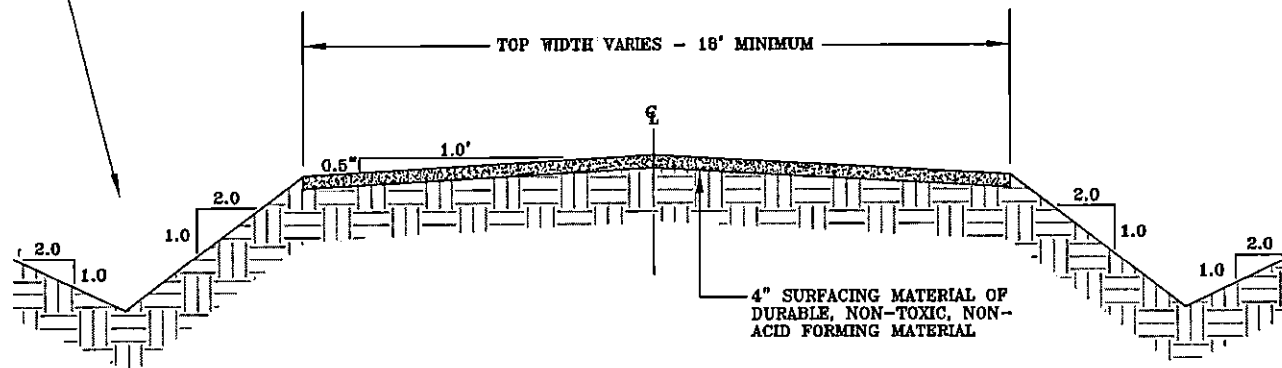

DRAINAGE DITCH TO BE LINED WITH GRASS MIXTURE.  
SEE SPECIFICATIONS. SEE DETAILED DESIGN PLANS FOR  
SPECIFIC DESIGN REQUIREMENTS.

**DIVERSION DITCH  
TYPICAL CROSS-SECTION**

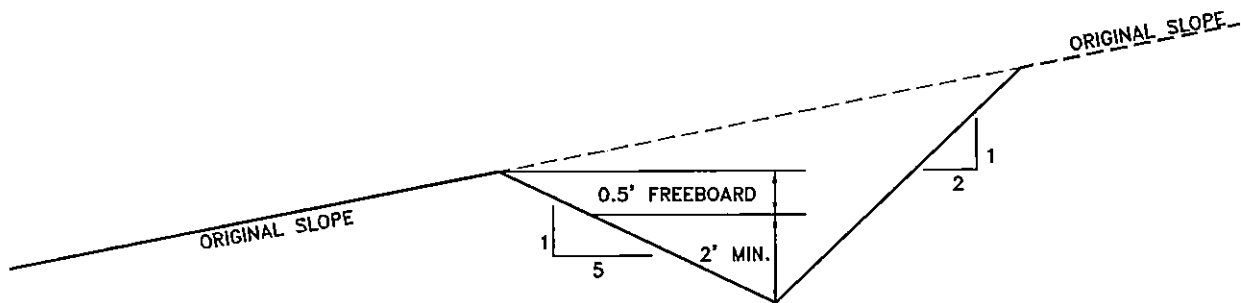

DITCH PROTECTIVE LINER: GRASS MIXTURE, PREDOMINATELY BERMUDA AND FESCUE GRASSES.  
CHANNEL BED SLOPE: 1.1% - 2.27%



**ATTACHMENT III-B-3**

**DIVERSION DITCH WITH BERM  
TYPICAL CROSS-SECTION**

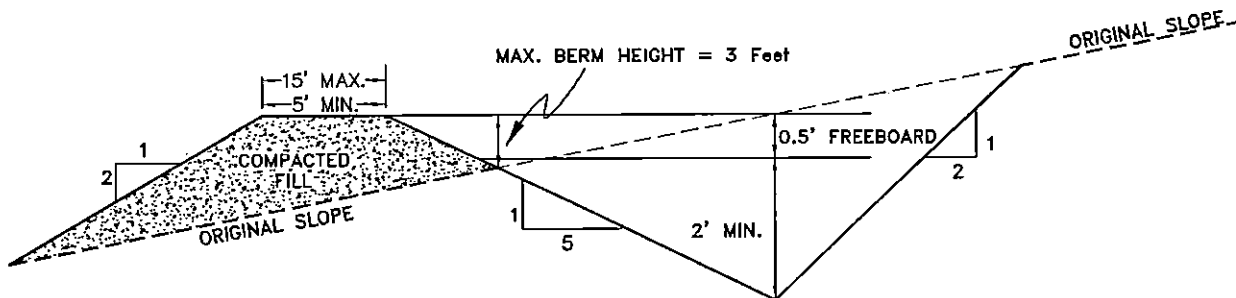

DITCH PROTECTIVE LINER: GRASS MIXTURE, PREDOMINATELY BERMUDA AND FESCUE GRASSES.  
DISCHARGE: 7.2 CFS  
CHANNEL BED SLOPE: 2.0%



# TYPICAL SILT FENCE CONSTRUCTION LAYOUT

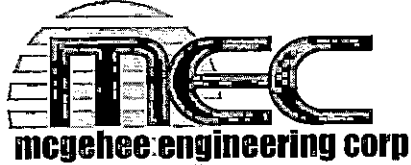
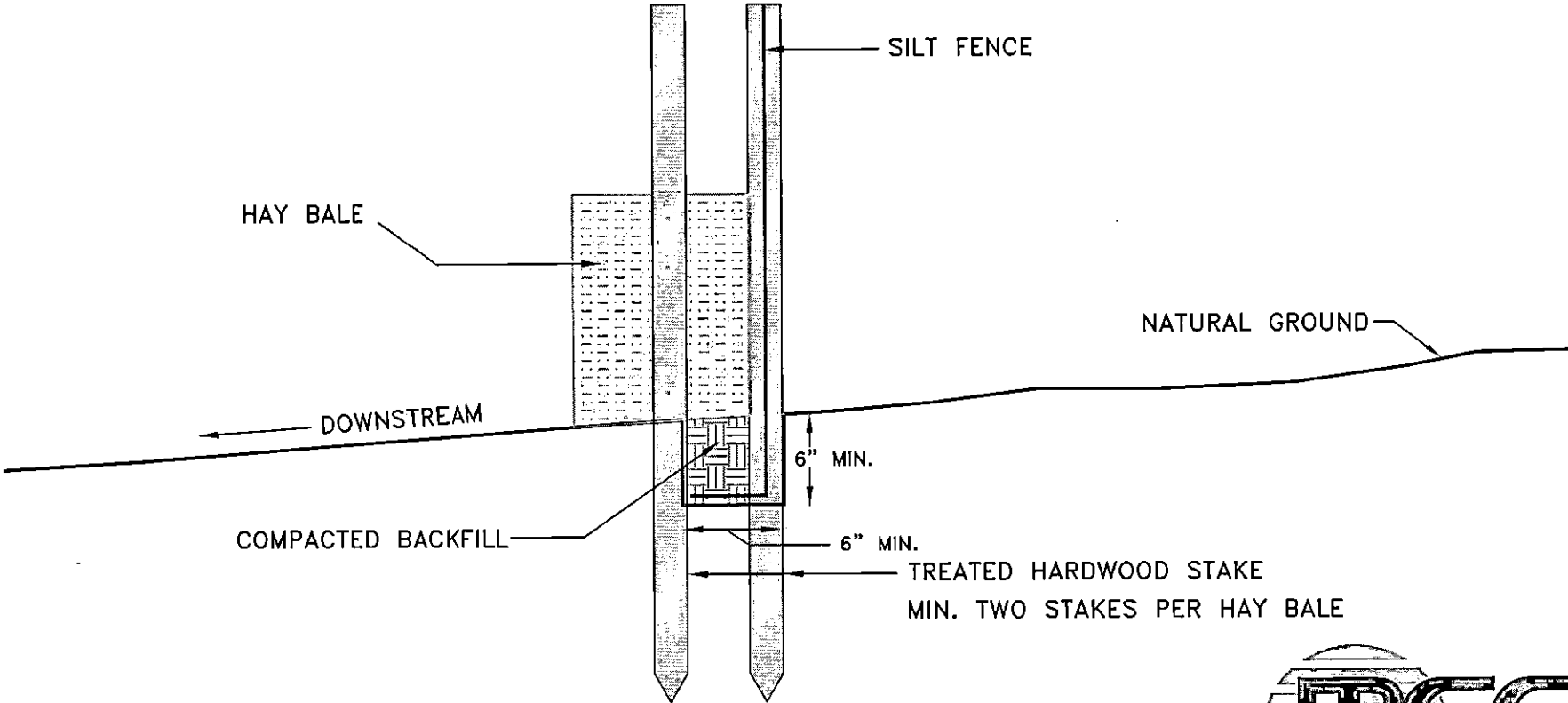

post office box 3431  
jasper, alabama 35502-3431  
telephone: (205) 221-0686 fax: 221-7721  
email: cw@mcgehee.org

# TYPICAL SILT FENCE CONSTRUCTION LAYOUT

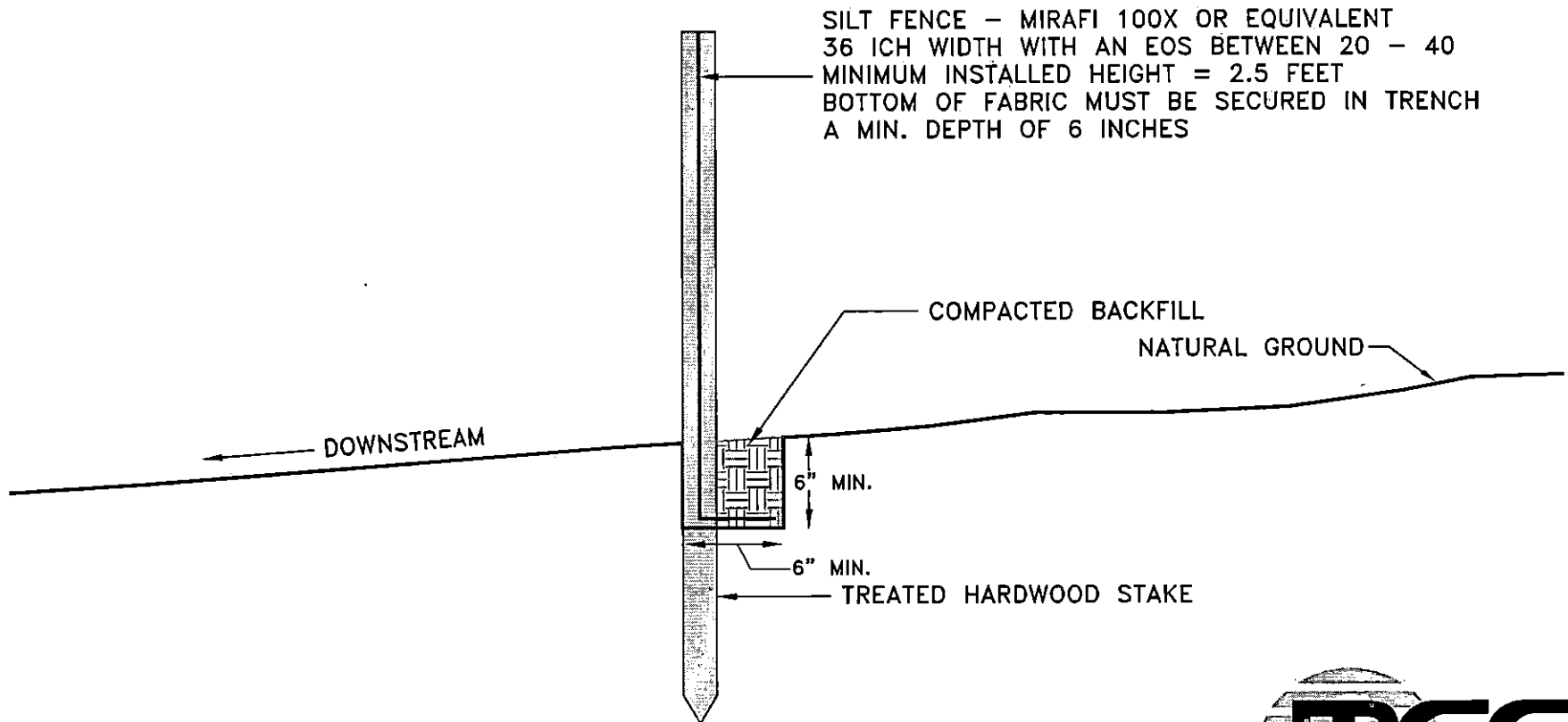

**MEC**  
mcgehee engineering corp  
post office box 3431  
jasper, alabama 35502-3431  
telephone: (205) 221-0686 fax: 221-7721  
email: cw@mcgehee.org

**SPILL PREVENTION CONTROL AND COUNTERMEASURES PLAN**

Prepared for:

**Alabama Department of Environmental Management**

**WHITAKER CONTRACTING CORP.**

**BROOKSVILLE SAND QUARRY**

**NPDES Permit**

Prepared by:

**MCGEHEE ENGINEERING CORP.**

**P. O. Box 3431**

**Jasper, Alabama 35502-3431**

**Telephone (205) 221-0686**

**Location:** Sections 16 & 17, Township 10 South, Range 2 East,  
Blount County, Alabama

**Facility Phone Number:** 256-582-2636

**Facility Contact and Address:**

*Lynn McWhorter, 692 Convict Camp Road, Guntersville, AL 35976*

1. This facility has never experienced a spill from any fuel or other chemical storage tanks.
2. The containment structures will be located in an area that is not subject to periodic flooding.
3. This plan provides for the containment of the following:

<u>No. Of Tanks</u>	<u>Total Capacity</u>	<u>Material</u>
1	8,000 gal	Diesel Fuel
1	6,000 gal	Diesel Fuel
1	500 gal	Used Oil
1	350 gal	Used Oil
1	250 gal	Transmission Fluid
1	250 gal	Motor Oil
1	55 gal	Hydraulic Oil
1	55 gal	Grease

4. The nearest surface water of the State is UT to Mill Branch which is located adjacent to the facility.
5. Containment is provided for the 8,000 gallon, 6,000 gallon, two 250 gallon and the 500 gallon permanent ASTs in the form of concrete walls. The capacity is sufficient to hold the contents of the largest tank plus a precipitation event equivalent to 10% of the largest tank.
6. If a spill should occur, the usable fuel oil within the diked area shall immediately be pumped into tanker trucks for transporting to another storage tank. Oil absorbent material will be kept available to contain any spills. The unusable fuel oil and the contaminated soil in the area will be excavated and disposed of in accordance with existing State and Federal regulations.
7. A written record shall be maintained by the Division Manager of any spill which occurs, and the actions taken to properly dispose of all spilled material and the cleanup procedures.
8. All unloading of transport vehicles to fill the tanks will meet minimum requirements and regulations established by the Department of Transportation. The tanks will be attended while filling to prevent overflow, and to note visible leaks from seams, gaskets, valves, etc. The Operations Manager of the facility will make periodic inspections of the unloading area to detect signs of minor spills. If spills are evident the contaminated soil will be disposed of in accordance with existing State and Federal regulations. If the spills continue, a paved unloading ramp equipped with an oil-water separator will be constructed.

9. All personnel who are in any way connected with unloading transport vehicles, use of fuel oil, maintenance of the facility, or responsible for storm water drainage and spill cleanup will be made familiar with this plan, and a copy of this plan will be posted and readily available to all personnel at the facility.

Potential Sources of Spills:

A. Tank or Tank Valve Rupture:

Prevention: Tanks, valves, and fittings will be properly maintained and kept in good condition. A visual inspection of all tanks, valves, and fittings will be conducted periodically for leaks, and tank foundations for cracks and unusual settling.

B. Tank Overfill:

Prevention: Truck drivers should follow correct operating procedures when unloading diesel fuel and stay with the equipment at all times during unloading operations. Key personnel will be present when fuel and/or other chemicals are delivered to assure that the delivery personnel follow proper procedures. Any spillage will be immediately cleaned-up or mitigated in accordance with this plan.

C. Hose Rupture During Unloading and Spillage from Hoses after Disconnection:

Prevention: Periodic inspections will be conducted of all hoses and replacement hoses will be kept at the facility office. In addition, personnel will use the proper hose drainage procedure.



10. Notification

In the event of a reportable quantity spill, immediately call:

The National Response Center  
1-800-424-8802

The Alabama Emergency Management Agency  
1-800-843-0699

Alabama Department of Environmental Management Water Division  
1400 Coliseum Boulevard Montgomery, Alabama 36110  
Telephone Number: (334) 271-7700

Alabama Department of Environmental Management Field Operations  
1400 Coliseum Boulevard Montgomery, Alabama 36110  
Telephone Number: (334) 271-7700

Report the following information:

1. Name, address and telephone number of person reporting spill
2. Exact location of facility and spill
3. Company name, number and location
4. Material spilled
5. Estimated quantity
6. Source of spill
7. Cause of spill
8. Nearest downstream body of water to receive spill
9. Request actions to take for containment and cleanup

II. The facility will be kept gated and locked to prevent vandalism or theft whenever Whitaker Contracting Corp. personnel are not present.

All key personnel will be fully trained in all aspects of this plan, the proper use of personal protective gear, and all reporting and record keeping procedures. All non-key personnel will be made familiar with the plan and will be instructed on personal safety.

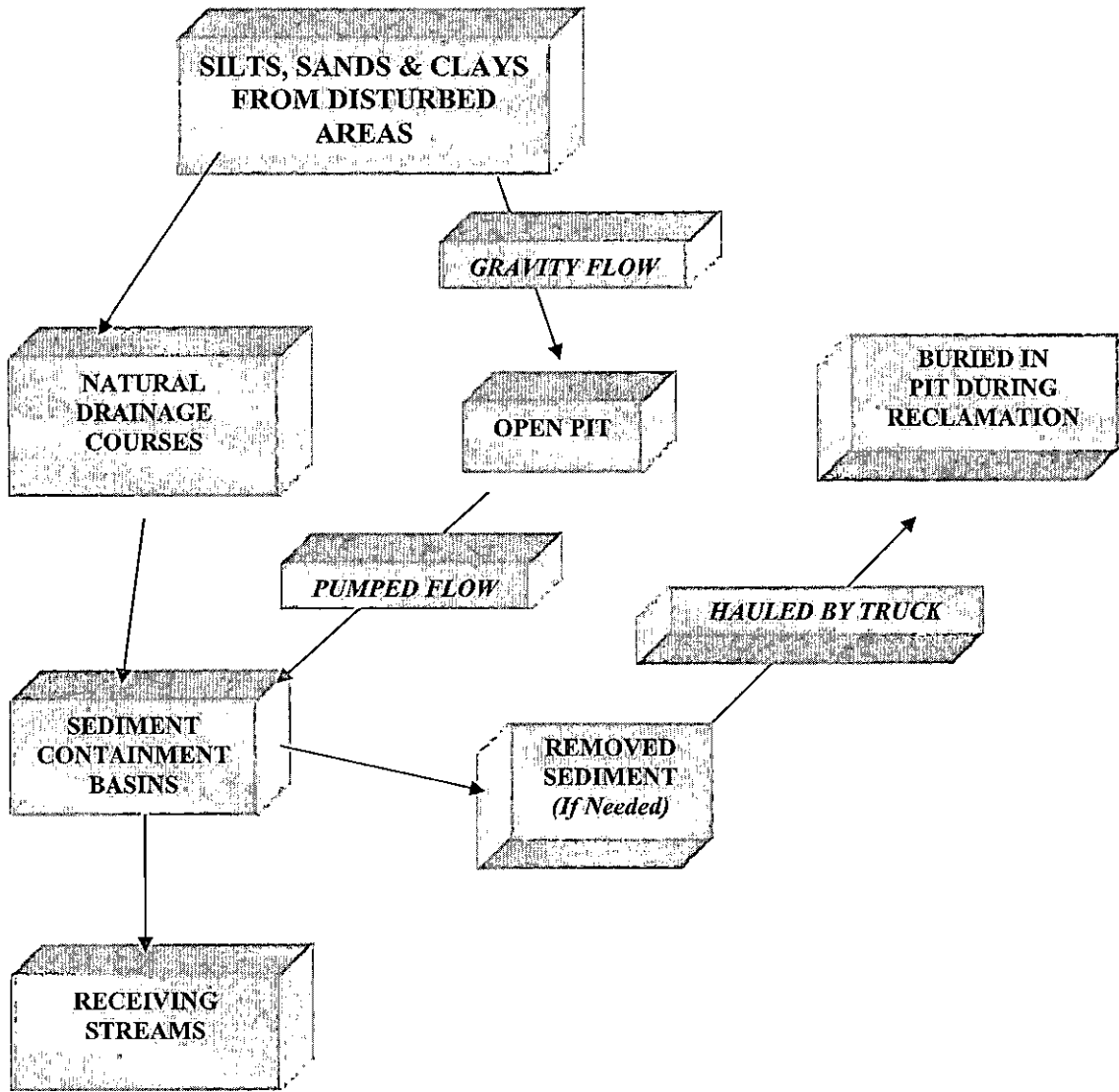

**SCHEMATIC DIAGRAM  
OF  
WASTE CYCLE**

# TYPICAL CONSTRUCTION LAYOUT FOR CONCRETE CONTAINMENT AREA

THE VOLUME OF THE CONTAINMENT AREA WILL EXCEED 110% OF THE LARGEST TANK.

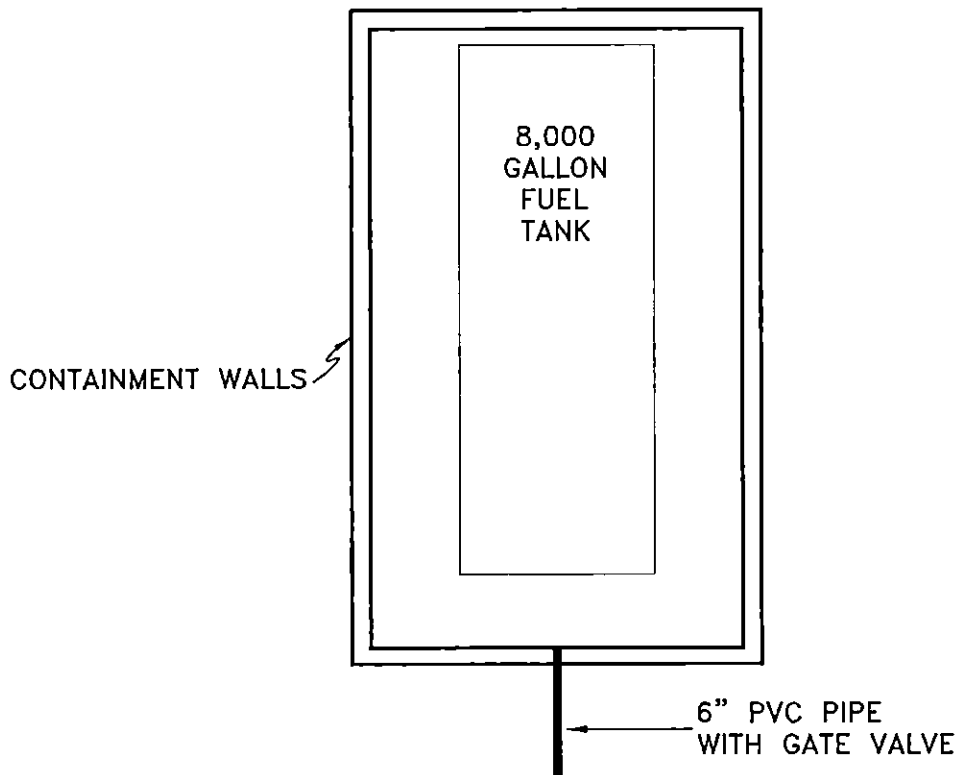

Gate valve to be locked at all times Whitaker Contracting Corp. personnel are not present.

