



Alabama Department of Environmental Management
adem.alabama.gov

1400 Coliseum Blvd. 36110-2400 ■ Post Office Box 301463
Montgomery, Alabama 36130-1463
(334) 271-7700 ■ FAX (334) 271-7950

JAN 13 2021

Billy May, Chairman
Utilities Board of the Town of Gilbertown
13217 Choctaw Ave
Gilbertown, AL 36908

RE: Final Permit
NPDES Permit No. AL0082848
Gilbertown Water Resources Recovery Facility
Choctaw County, Alabama

Dear Mr. May:

Transmitted herein is a draft of the referenced permit.

We would appreciate your comments on the permit within **30 days** of the date of this letter. Please direct any comments of a technical or administrative nature to the undersigned.

By copy of this letter and the draft permit, we are also requesting comments within the same time frame from EPA.

Please be aware that Part I.C.1.c of your permit requires participation in the Department's web-based Electronic Environmental (E2) Reporting System Program for submittal of DMRs upon issuance of this permit unless valid justification as to why you cannot participate is submitted in writing. Please also be aware that Part I.C.2.e of your permit requires participation in the Department's web-based electronic environmental (E2) reporting system for submittal of SSOs unless valid justification as to why you cannot participate is submitted in writing. SSO hotline notifications and hard copy Form 415 SSO reports may be used only with the written approval from the Department. The E2 Program allows ADEM to electronically validate, acknowledge receipt, and upload data to the state's central wastewater database. This improves the accuracy of reported compliance data and reduces costs to both the regulated community and ADEM. The Permittee Participation Package may be downloaded online at <https://e2.adem.alabama.gov/npdes> or you may obtain a hard copy by submitting a written request or by emailing e2admin@adem.alabama.gov.

Please also be aware that Part IV. of your permit requires that you develop, implement, and maintain a Sanitary Sewer Overflow Response Plan.

The Alabama Department of Environmental Management encourages you to voluntarily consider pollution prevention practices and alternatives at your facility. Pollution Prevention may assist you in complying with effluent limitations, and possibly reduce or eliminate monitoring requirements.

Should you have any questions, please contact the undersigned by email at michael.simmons@adem.alabama.gov or by phone at (334) 274-4220.

Sincerely,

A handwritten signature in black ink, appearing to read "Michael N. Simmons".

Michael N. Simmons
Municipal Section
Water Division

mns/mfc
Enclosure

cc: Environmental Protection Agency Email
Ms. Elaine Snyder/U.S. Fish and Wildlife Service
Ms. Elizabeth Brown/Alabama Historical Commission
Advisory Council on Historic Preservation
Department of Conservation and Natural Resources

Birmingham Branch
110 Vulcan Road
Birmingham, AL 35209-4702
(205) 942-6168
(205) 941-1603 (FAX)

Decatur Branch
2715 Sandlin Road, S.W.
Decatur, AL 35603-1333
(256) 353-1713
(256) 340-9359 (FAX)



Mobile Branch
2204 Perimeter Road
Mobile, AL 36615-1131
(251) 450-3400
(251) 479-2593 (FAX)

Mobile-Coastal
3664 Dauphin Street, Suite B
Mobile, AL 36608
(251) 304-1176
(251) 304-1189 (FAX)



NATIONAL POLLUTANT DISCHARGE ELIMINATION SYSTEM PERMIT

PERMITTEE: UTILITIES BOARD OF THE TOWN OF GILBERTOWN
13217 CHOCTAW AVE
GILBERTOWN, ALABAMA 36908

FACILITY LOCATION: GILBERTOWN WATER RESOURCES RECOVERY FACILITY (0.06 MGD)
13217 CHOCTAW AVE
GILBERTOWN, ALABAMA
CHOCTAW COUNTY

PERMIT NUMBER: AL0082848

RECEIVING WATERS: OKATUPPA CREEK

In accordance with and subject to the provisions of the Federal Water Pollution Control Act, as amended, 33 U.S.C. §§1251-1388 (the "FWPCA"), the Alabama Water Pollution Control Act, as amended, Code of Alabama 1975, §§ 22-22-1 to 22-22-14 (the "AWPCA"), the Alabama Environmental Management Act, as amended, Code of Alabama 1975, §§22-22A-1 to 22-22A-17, and rules and regulations adopted thereunder, and subject further to the terms and conditions set forth in this permit, the Permittee is hereby authorized to discharge into the above-named receiving waters.

ISSUANCE DATE:

EFFECTIVE DATE:

EXPIRATION DATE:

Draft

Alabama Department of Environmental Management

**MUNICIPAL SECTION
NATIONAL POLLUTANT DISCHARGE ELIMINATION SYSTEM (NPDES)
PERMIT**

TABLE OF CONTENTS

PART I	DISCHARGE LIMITATIONS, CONDITIONS, AND REQUIREMENTS	4
A.	DISCHARGE LIMITATIONS AND MONITORING REQUIREMENTS	4
1.	Outfall 0011 Discharge Limits - Effluent	4
B.	DISCHARGE MONITORING AND RECORD KEEPING REQUIREMENTS	5
1.	Representative Sampling.....	5
2.	Measurement Frequency	5
3.	Test Procedures	5
4.	Recording of Results.....	5
5.	Records Retention and Production.....	6
6.	Reduction, Suspension or Termination of Monitoring and/or Reporting.....	6
7.	Monitoring Equipment and Instrumentation	6
C.	DISCHARGE REPORTING REQUIREMENTS	6
1.	Reporting of Monitoring Requirements	6
2.	Noncompliance Notifications and Reports.....	8
D.	OTHER REPORTING AND NOTIFICATION REQUIREMENTS.....	10
1.	Anticipated Noncompliance.....	10
2.	Termination of Discharge	10
3.	Updating Information.....	10
4.	Duty to Provide Information	10
E.	SCHEDULE OF COMPLIANCE	10
1.	Compliance with discharge limits.....	10
2.	Schedule.....	10
PART II	OTHER REQUIREMENTS, RESPONSIBILITIES, AND DUTIES.....	11
A.	OPERATIONAL AND MANAGEMENT REQUIREMENTS.....	11
1.	Facilities Operation and Maintenance.....	11
2.	Best Management Practices (BMP)	11
3.	Certified Operator	11
B.	OTHER RESPONSIBILITIES.....	11
1.	Duty to Mitigate Adverse Impacts	11
2.	Right of Entry and Inspection	11
C.	BYPASS AND UPSET	11
1.	Bypass.....	11
2.	Upset.....	12
D.	DUTY TO COMPLY WITH PERMIT, RULES, AND STATUTES	12
1.	Duty to Comply.....	12
2.	Removed Substances.....	12
3.	Loss or Failure of Treatment Facilities	12
4.	Compliance With Statutes and Rules	13
E.	PERMIT TRANSFER, MODIFICATION, SUSPENSION, REVOCATION, AND REISSUANCE	13
1.	Duty to Reapply or Notify of Intent to Cease Discharge	13
2.	Change in Discharge	13
3.	Transfer of Permit	13
4.	Permit Modification and Revocation	13
5.	Termination.....	14
6.	Suspension	14
7.	Stay	14
F.	COMPLIANCE WITH TOXIC POLLUTANT STANDARD OR PROHIBITION.....	15

G.	NOTICE TO DIRECTOR OF INDUSTRIAL USERS.....	15
H.	PROHIBITIONS.....	15
PART III	ADDITIONAL REQUIREMENTS, CONDITIONS, AND LIMITATIONS.....	16
A.	CIVIL AND CRIMINAL LIABILITY.....	16
1.	Tampering.....	16
2.	False Statements.....	16
3.	Permit Enforcement.....	16
4.	Relief from Liability.....	16
B.	OIL AND HAZARDOUS SUBSTANCE LIABILITY.....	16
C.	PROPERTY AND OTHER RIGHTS.....	16
D.	AVAILABILITY OF REPORTS.....	16
E.	EXPIRATION OF PERMITS FOR NEW OR INCREASED DISCHARGES.....	17
F.	COMPLIANCE WITH WATER QUALITY STANDARDS.....	17
G.	GROUNDWATER.....	17
H.	DEFINITIONS.....	17
I.	SEVERABILITY.....	20
PART IV	SPECIFIC REQUIREMENTS, CONDITIONS, AND LIMITATIONS.....	21
A.	SLUDGE MANAGEMENT PRACTICES.....	21
1.	Applicability.....	21
2.	Submitting Information.....	21
3.	Reopener or Modification.....	21
B.	EFFLUENT TOXICITY TESTING REOPENER.....	21
C.	TOTAL RESIDUAL CHLORINE (TRC) REQUIREMENTS.....	21
D.	PLANT CLASSIFICATION.....	22
E.	SANITARY SEWER OVERFLOW RESPONSE PLAN.....	22
1.	SSO Response Plan.....	22
2.	SSO Response Plan Implementation.....	23
3.	Department Review of the SSO Response Plan.....	23
4.	SSO Response Plan Administrative Procedures.....	23

PART I

DISCHARGE LIMITATIONS, CONDITIONS, AND REQUIREMENTS

A. DISCHARGE LIMITATIONS AND MONITORING REQUIREMENTS

I. Outfall 0011 Discharge Limits - Effluent

During the period beginning on the effective date of this permit and lasting through the expiration date of this permit, the Permittee is authorized to discharge from Outfall 0011, which is described more fully in the Permittee's application. Such discharge shall be limited and monitored by the Permittee as specified below:

Parameter	Discharge Limitations*							Monitoring Requirements**			
	Monthly Average	Weekly Average	Monthly Average	Weekly Average	Daily Minimum	Daily Maximum	Percent Removal	(1) Sample Location	(2) Sample Type	(3) Measurement Frequency	(4) Seasonal
Oxygen, Dissolved (DO) 00300 I 0 0	*****	*****	*****	*****	REPORT mg/l	*****	*****	E	GRAB	F	*****
pH 00400 I 0 0	*****	*****	*****	*****	6.0 S.U.	9.0 S.U.	*****	E	GRAB	F	*****
Solids, Total Suspended 00530 I 0 0	15.0 lbs/day	22.5 lbs/day	30.0 mg/l	45.0 mg/l	*****	*****	*****	E	COMP-8	F	*****
Solids, Total Suspended 00530 G 0 0	REPORT lbs/day	REPORT lbs/day	REPORT mg/l	REPORT mg/l	*****	*****	*****	I	COMP-8	F	*****
Nitrogen, Ammonia Total (As N) 00610 I 0 0	10.0 lbs/day	15.0 lbs/day	20.0 mg/l	30.0 mg/l	*****	*****	*****	E	COMP-8	F	*****
Nitrogen, Kjeldahl Total (As N) 00625 I 0 0	REPORT lbs/day	REPORT lbs/day	REPORT mg/l	REPORT mg/l	*****	*****	*****	E	COMP-8	G	S
Nitrite Plus Nitrate Total I Det. (As N) 00630 I 0 0	REPORT lbs/day	REPORT lbs/day	REPORT mg/l	REPORT mg/l	*****	*****	*****	E	COMP-8	G	S
Phosphorus, Total (As P) 00665 I 0 0	REPORT lbs/day	REPORT lbs/day	REPORT mg/l	REPORT mg/l	*****	*****	*****	E	COMP-8	G	S
Flow, In Conduit or Thru Treatment Plant 50050 I 0 0	REPORT MGD	*****	*****	*****	*****	REPORT MGD	*****	E	INSTAN	F	*****
Chlorine, Total Residual See note (5) 50060 I 0 0	*****	*****	0.22 mg/l	*****	*****	0.38 mg/l	*****	E	GRAB	F	*****
E. Coli 51040 I 0 0	*****	*****	126 col/100mL	*****	*****	298 col/100mL	*****	E	GRAB	F	ECS
E. Coli 51040 I 0 0	*****	*****	548 col/100mL	*****	*****	2507 col/100mL	*****	E	GRAB	F	ECW
BOD, Carbonaceous 05 Day, 20C 80082 I 0 0	12.5 lbs/day	18.7 lbs/day	25.0 mg/l	37.5 mg/l	*****	*****	*****	E	COMP-8	F	*****
BOD, Carbonaceous 05 Day, 20C 80082 G 0 0	REPORT lbs/day	REPORT lbs/day	REPORT mg/l	REPORT mg/l	*****	*****	*****	I	COMP-8	F	*****
BOD, Carb-5 Day, 20 Deg C, Percent Remvl 80091 K 0 0	*****	*****	*****	*****	*****	*****	85%	K	CALCTD	G	*****
Solids, Suspended Percent Removal 81011 K 0 0	*****	*****	*****	*****	*****	*****	85%	K	CALCTD	G	*****

* See Part II.C.1. (Bypass); Part II.C.2. (Upset)

** Monitoring Requirements

(1) Sample Location

- I - Influent
- E - Effluent
- X - End Chlorine Contact Chamber
- K - Percent Removal of the Monthly Avg. Influent Concentration from the Monthly Avg. Effluent Concentration.
- RS - Receiving Stream

(2) Sample Type:

- CONTIN - Continuous
- INSTAN - Instantaneous
- COMP-8 - 8-Hour Composite
- COMP24 - 24-Hour Composite
- GRAB - Grab
- CALCTD - Calculated

(3) Measurement Frequency: See also Part I.B.2.

- A - 7 days per week
- B - 5 days per week
- C - 3 days per week
- D - 2 days per week
- E - 1 day per week
- F - 2 days per month
- G - 1 day per month
- H - 1 day per quarter
- J - Annual
- Q - For Effluent Toxicity Testing, see Provision IV.B.

(4) Seasonal Limits:

- S = Summer (April - October)
- W = Winter (November - March)
- ECS = E. coli Summer (May - October)
- ECW = E. coli Winter (November - April)

(5) See Part IV.C. for Total Residual Chlorine (TRC). Monitoring for TRC is applicable if chlorine is utilized for disinfection purposes. If monitoring is not applicable during the monitoring period, enter “*9” or “NODI=9” (if hard copy) on the monthly DMR.

B. DISCHARGE MONITORING AND RECORD KEEPING REQUIREMENTS

1. Representative Sampling

Sample collection and measurement actions shall be representative of the volume and nature of the monitored discharge and shall be in accordance with the provisions of this permit. The effluent sampling point shall be at the nearest accessible location just prior to discharge and after final treatment, unless otherwise specified in the permit.

2. Measurement Frequency

Measurement frequency requirements found in Provision I.A. shall mean:

- a. Seven days per week shall mean daily.
- b. Five days per week shall mean any five days of discharge during a calendar weekly period of Sunday through Saturday.
- c. Three days per week shall mean any three days of discharge during a calendar week.
- d. Two days per week shall mean any two days of discharge during a calendar week.
- e. One day per week shall mean any day of discharge during a calendar week.
- f. Two days per month shall mean any two days of discharge during the month that are no less than seven days apart. However, if discharges occur only during one seven-day period in a month, then two days per month shall mean any two days of discharge during that seven day period.
- g. One day per month shall mean any day of discharge during the calendar month.
- h. Quarterly shall mean any day of discharge during each calendar quarter.
- i. The Permittee may increase the frequency of sampling, listed in Provisions I.B.2.a through I.B.2.h; however, all sampling results are to be reported to the Department.

3. Test Procedures

For the purpose of reporting and compliance, Permittees shall use one of the following procedures:

- a. For parameters with an EPA established Minimum Level (ML), report the measured value if the analytical result is at or above the ML and report "0" for values below the ML. Test procedures for the analysis of pollutants shall conform to 40 CFR Part 136 and guidelines published pursuant to Section 304(h) of the FWPCA, 33 U.S.C. Section 1314(h). If more than one method for analysis of a substance is approved for use, a method having a minimum level lower than the permit limit shall be used. If the minimum level of all methods is higher than the permit limit, the method having the lowest minimum level shall be used and a report of less than the minimum level shall be reported as zero and will constitute compliance, however should EPA approve a method with a lower minimum level during the term of this permit the Permittee shall use the newly approved method.

- b. For pollutants parameters without an established ML, an interim ML may be utilized. The interim ML shall be calculated as 3.18 times the Method Detection Level (MDL) calculated pursuant to 40 CFR Part 136, Appendix B.

Permittees may develop an effluent matrix-specific ML, where an effluent matrix prevents attainment of the established ML. However, a matrix specific ML shall be based upon proper laboratory method and technique. Matrix-specific MLs must be approved by the Department, and may be developed by the Permittee during permit issuance, reissuance, modification, or during compliance schedule.

In either case the measured value should be reported if the analytical result is at or above the ML and "0" reported for values below the ML.

- c. For parameters without an EPA established ML, interim ML, or matrix-specific ML, a report of less than the detection limit shall constitute compliance if the detection limit of all analytical methods is higher than the permit limit. For the purpose of calculating a monthly average, "0" shall be used for values reported less than the detection limit.

The Minimum Level utilized for procedures a and b above shall be reported on the Permittee's DMR. When an EPA approved test procedure for analysis of a pollutant does not exist, the Director shall approve the procedure to be used.

4. Recording of Results

For each measurement or sample taken pursuant to the requirements of this permit, the Permittee shall record the following information:

- a. The facility name and location, point source number, date, time and exact place of sampling;

- b. The name(s) of person(s) who obtained the samples or measurements;
 - c. The dates and times the analyses were performed;
 - d. The name(s) of the person(s) who performed the analyses;
 - e. The analytical techniques or methods used, including source of method and method number; and
 - f. The results of all required analyses.
5. Records Retention and Production
- a. The Permittee shall retain records of all monitoring information, including all calibration and maintenance records and all original strip chart recordings for continuous monitoring instrumentation, copies of all reports required by the permit, and records of all data used to complete the above reports or the application for this permit, for a period of at least three years from the date of the sample measurement, report or application. This period may be extended by request of the Director at any time. If litigation or other enforcement action, under the AWPCA and/or the FWPCA, is ongoing which involves any of the above records, the records shall be kept until the litigation is resolved. Upon the written request of the Director or his designee, the Permittee shall provide the Director with a copy of any record required to be retained by this paragraph. Copies of these records should not be submitted unless requested.
 - b. All records required to be kept for a period of three years shall be kept at the permitted facility or an alternate location approved by the Department in writing and shall be available for inspection.
6. Reduction, Suspension or Termination of Monitoring and/or Reporting
- a. The Director may, with respect to any point source identified in Provision I.A. of this permit, authorize the Permittee to reduce, suspend or terminate the monitoring and/or reporting required by this permit upon the submission of a written request for such reduction, suspension or termination by the Permittee, supported by sufficient data which demonstrates to the satisfaction of the Director that the discharge from such point source will continuously meet the discharge limitations specified in Provision I.A. of this permit.
 - b. It remains the responsibility of the Permittee to comply with the monitoring and reporting requirements of this permit until written authorization to reduce, suspend or terminate such monitoring and/or reporting is received by the Permittee from the Director.
7. Monitoring Equipment and Instrumentation
- All equipment and instrumentation used to determine compliance with the requirements of this permit shall be installed, maintained, and calibrated in accordance with the manufacturer's instructions or, in the absence of manufacturer's instructions, in accordance with accepted practices. At a minimum, flow measurement devices shall be calibrated at least once every 12 months.

C. DISCHARGE REPORTING REQUIREMENTS

1. Reporting of Monitoring Requirements
 - a. The Permittee shall conduct the required monitoring in accordance with the following schedule:
 - (1) **MONITORING REQUIRED MORE FREQUENTLY THAN MONTHLY AND MONTHLY** shall be conducted during the first full month following the effective date of coverage under this permit and every month thereafter.
 - (2) **QUARTERLY MONITORING** shall be conducted at least once during each calendar quarter. Calendar quarters are the periods of January through March, April through June, July through September, and October through December. The Permittee shall conduct the quarterly monitoring during the first complete calendar quarter following the effective date of this permit and is then required to monitor once during each quarter thereafter. Quarterly monitoring should be reported on the last DMR due for the quarter (i.e., March, June, September and December DMRs).
 - (3) **SEMIANNUAL MONITORING** shall be conducted at least once during the period of January through June and at least once during the period of July through December. The Permittee shall conduct the semiannual monitoring during the first complete calendar semiannual period following the effective date of this permit and is then required to monitor once during each semiannual period thereafter. Semiannual monitoring may be done anytime during the semiannual period, unless restricted elsewhere in this permit, but it should be reported on the last DMR due for the month of the semiannual period (i.e., June and December DMRs).
 - (4) **ANNUAL MONITORING** shall be conducted at least once during the period of January through December. The Permittee shall conduct the annual monitoring during the first complete calendar annual period following the effective date of this permit and is then required to monitor once during each annual period thereafter.

Annual monitoring may be done anytime during the year, unless restricted elsewhere in this permit, but it should be reported on the December DMR.

- b. The Permittee shall submit discharge monitoring reports (DMRs) on the forms approved by the Department and in accordance with the following schedule:
- (1) **REPORTS OF MORE FREQUENTLY THAN MONTHLY AND MONTHLY TESTING** shall be submitted on a monthly basis. The first report is due on the 28th day of the month following the month the permit becomes effective. The reports shall be submitted so that they are received by the Department no later than the 28th day of the month following the reporting period, unless otherwise directed by the Department.
 - (2) **REPORTS OF QUARTERLY TESTING** shall be submitted on a quarterly basis. The first report is due on the 28th day of the month following the first complete calendar quarter the permit becomes effective. The reports shall be submitted so that they are received by the Department no later than the 28th day of the month following the reporting period, unless otherwise directed by the Department.
 - (3) **REPORTS OF SEMIANNUAL TESTING** shall be submitted on a semiannual basis. The reports are due on the 28th day of JANUARY and the 28th day of JULY. The reports shall be submitted so that they are received by the Department no later than the 28th day of the month following the reporting period, unless otherwise directed by the Department.
 - (4) **REPORTS OF ANNUAL TESTING** shall be submitted on an annual basis. Unless specified elsewhere in the permit, the first report is due on the 28th day of JANUARY. The reports shall be submitted so that they are received by the Department no later than the 28th day of the month following the reporting period, unless otherwise directed by the Department.
- c. Except as allowed by Provision I.C.1.c.(1) or (2), the permittee shall submit all Discharge Monitoring Reports (DMRs) required by Provision I.C.1.b. by utilizing the Department's web-based Electronic Environmental (E2) Reporting System.
- (1) If the permittee is unable to complete the electronic submittal of DMR data due to technical problems originating with the Department's E2 Reporting System (this could include entry/submittal issues with an entire set of DMRs or individual parameters), the permittee is not relieved of their obligation to submit DMR data to the Department by the date specified in Provision I.C.1.b., unless otherwise directed by the Department.

If the E2 Reporting System is down on the 28th day of the month in which the DMR is due or is down for an extended period of time, as determined by the Department, when a DMR is required to be submitted, the permittee may submit the data in an alternate manner and format acceptable to the Department. Preapproved alternate acceptable methods include faxing, e-mailing, mailing, or hand-delivery of data such that they are received by the required reporting date. Within five calendar days of the E2 Reporting System resuming operation, the permittee shall enter the data into the E2 Reporting System, unless an alternate timeframe is approved by the Department. An attachment should be included with the E2 DMR submittal verifying the original submittal date (date of the fax, copy of dated e-mail, or hand-delivery stamped date), if applicable.
 - (2) The permittee may submit a request to the Department for a temporary electronic reporting waiver for DMR submittals. The waiver request should include the permit number; permittee name; facility/site name; facility address; name, address, and contact information for the responsible official or duly authorized representative; a detailed statement regarding the basis for requesting such a waiver; and the duration for which the waiver is requested. Approved electronic reporting waivers are not transferrable.

A permittee with an approved electronic reporting waiver for DMRs may submit hard copy DMRs for the period that the approved electronic reporting waiver request is effective. The permittee shall submit the Department-approved DMR forms to the address listed in Provision I.C.1.e.
 - (3) If a permittee is allowed to submit a hard copy DMR, the DMR must be legible and bear an original signature. Photo and electronic copies of the signature are not acceptable and shall not satisfy the reporting requirements of this permit.
 - (4) If the permittee, using approved analytical methods as specified in Provision I.B.2, monitors any discharge from a point source for a limited substance identified in Provision I.A. of this permit more frequently than required by this permit, the results of such monitoring shall be included in the calculation and reporting of values on the DMR and the increased frequency shall be indicated on the DMR.
 - (5) In the event no discharge from a point source identified in Provision I.A. of this permit and described more fully in the permittee's application occurs during a monitoring period, the permittee shall report "No Discharge" for such period on the appropriate DMR.
- d. All reports and forms required to be submitted by this permit, the AWPCA and the Department's Rules and Regulations, shall be electronically signed (or, if allowed by the Department, traditionally signed) by a "responsible

official" of the permittee as defined in ADEM Administrative Code Rule 335-6-6-.09 or a "duly authorized representative" of such official as defined in ADEM Administrative Code Rule 335-6-6-.09 and shall bear the following certification:

"I certify under penalty of law that this document and all attachments were prepared under my direction or supervision in accordance with a system designed to assure that qualified personnel properly gather and evaluate the information submitted. Based on my inquiry of the person or persons who manage the system, or those persons directly responsible for gathering information, the information submitted is, to the best of my knowledge and belief, true, accurate, and complete. I am aware that there are significant penalties for submitting false information, including the possibility of fine and imprisonment for knowing violations."

- e. Discharge Monitoring Reports required by this permit, the AWPCA, and the Department's Rules that are being submitted in hard copy shall be addressed to:

**Alabama Department of Environmental Management
Environmental Data Section, Permits & Services Division
Post Office Box 301463
Montgomery, Alabama 36130-1463**

Certified and Registered Mail containing Discharge Monitoring Reports shall be addressed to:

**Alabama Department of Environmental Management
Environmental Data Section, Permits & Services Division
1400 Coliseum Boulevard
Montgomery, Alabama 36110-2400**

- f. All other correspondence and reports required to be submitted by this permit, the AWPCA, and the Department's Rules shall be addressed to:

**Alabama Department of Environmental Management
Municipal Section, Water Division
Post Office Box 301463
Montgomery, Alabama 36130-1463**

Certified and Registered Mail shall be addressed to:

**Alabama Department of Environmental Management
Municipal Section, Water Division
1400 Coliseum Boulevard
Montgomery, Alabama 36110-2400**

- g. If this permit is a reissuance, then the permittee shall continue to submit DMRs in accordance with the requirements of their previous permit until such time as DMRs are due as discussed in Part I.C.1.b. above.

2. Noncompliance Notifications and Reports

- a. The Permittee shall notify the Department if, for any reason, the Permittee's discharge:
- (1) Does not comply with any daily minimum or maximum discharge limitation for an effluent characteristic specified in Provision I.A. of this permit which is denoted by an "(X)";
 - (2) Potentially threatens human health or welfare;
 - (3) Threatens fish or aquatic life;
 - (4) Causes an in-stream water quality criterion to be exceeded;
 - (5) Does not comply with an applicable toxic pollutant effluent standard or prohibition established under Section 307(a) of the FWPCA, 33 U.S.C. Section 1317(a);
 - (6) Contains a quantity of a hazardous substance that may be harmful to public health or welfare under Section 311(b)(4) of the FWPCA, 33 U.S.C. Section 1321(b)(4);
 - (7) Exceeds any discharge limitation for an effluent parameter listed in Part I.A. as a result of an unanticipated bypass or upset; or
 - (8) Is an unpermitted direct or indirect discharge of a pollutant to a water of the state. (Note that unpermitted discharges properly reported to the Department under any other requirement are not required to be reported under this provision.)

The Permittee shall orally or electronically provide notification of any of the above occurrences, describing the circumstances and potential effects, to the Director or Designee within 24-hours after the Permittee becomes aware of the occurrence of such discharge. In addition to the oral or electronic notification, the Permittee shall submit a report to the Director or Designee, as provided in Provision I.C.2.c. or I.C.2.e., no later than five days after becoming aware of the occurrence of such discharge or occurrence.

- b. If, for any reason, the Permittee's discharge does not comply with any limitation of this permit, then the Permittee shall submit a written report to the Director or Designee, as provided in Provision I.C.2.c below. This report must be submitted with the next Discharge Monitoring Report required to be submitted by Provision I.C.1 of this permit after becoming aware of the occurrence of such noncompliance.
- c. Except for notifications and reports of notifiable SSOs which shall be submitted in accordance with the applicable Provisions of this permit, the Permittee shall submit the reports required under Provisions I.C.2.a. and b. to the Director or Designee on ADEM Form 421, available on the Department's website (<http://www.adem.state.al.us/DeptForms/Form421.pdf>). The completed Form must document the following information:
 - (1) A description of the discharge and cause of noncompliance;
 - (2) The period of noncompliance, including exact dates, times, and duration of the noncompliance. If the noncompliance is not corrected by the due date of the written report, then the Permittee shall provide an estimated date by which the noncompliance will be corrected; and
 - (3) A description of the steps taken by the Permittee and the steps planned to be taken by the Permittee to reduce or eliminate the noncompliant discharge and to prevent its recurrence.
- d. Immediate notification

The Permittee shall provide notification to the Director, the public, the county health department, and any other affected entity such as public water systems, as soon as possible upon becoming aware of any notifiable sanitary sewer overflow. Notification to the Director shall be completed utilizing the Department's web-based electronic environmental SSO reporting system in accordance with Provision I.C.2.e.

- e. The Department is utilizing a web-based electronic environmental (E2) reporting system for notification and submittal of SSO reports. **If the Permittee is not already participating in the E2 Reporting System for SSO reports, the Permittee must apply for participation in the system within 30 days of coverage under this permit unless the Permittee submits in writing valid justification as to why it cannot participate and the Department approves in writing utilization of verbal notifications and hard copy SSO report submittals.** Once the Permittee is enrolled in the E2 Reporting System for SSO reports, the Permittee must utilize the system for notification and submittal of all SSO reports unless otherwise allowed by this permit. The Permittee shall include in the SSO reports the information requested by ADEM Form 415. In addition, the Permittee shall include the latitude and longitude of the SSO in the report except when the SSO is a result of an extreme weather event (e.g., hurricane). To participate in the E2 Reporting System for SSO reports, the Permittee Participation Package may be downloaded online at <https://e2.adem.alabama.gov/npdes>. If the E2 Reporting System is down (i.e., electronic submittal of SSO data cannot be completed due to technical problems originating with the Department's system), the Permittee is not relieved of its obligation to notify the Department or submit SSO reports to the Department by the required submittal date, and the Permittee shall submit the data in an alternate manner and format acceptable to the Department. Preapproved alternate acceptable methods include verbal reports, reports submitted via the SSO hotline, or reports submitted via fax, e-mail, mail, or hand-delivery such that they are received by the required reporting date. Within five calendar days of the E2 Reporting System resuming operation, the Permittee shall enter the data into the E2 Reporting System, unless an alternate timeframe is approved by the Department. For any alternate notification, records of the date, time, notification method, and person submitting the notification should be maintained by the Permittee. If a Permittee is allowed to submit SSO reports via an alternate method, the SSO report must be in a format approved by the Department and must be legible.
- f. The Permittee shall maintain a record of all known wastewater discharge points that are not authorized as permitted outfalls, including but not limited to SSOs. The Permittee shall include this record in its Municipal Water Pollution Prevention (MWPP) Annual Reports, which shall be submitted to the Department each year by May 31st for the prior calendar year period beginning January 1st and ending December 31st. The MWPP Annual Reports shall contain a list of all known wastewater discharge points that are not authorized as permitted outfalls and any discharges that occur prior to the headworks of the wastewater treatment plant covered by this permit. The Permittee shall also provide in the MWPP Annual Reports a list of any discharges reported during the applicable time period in accordance with Provision I.C.2.a. The Permittee shall include in its MWPP Annual Reports the following information for each known unpermitted discharge that occurred:
 - (1) The cause of the discharge;

- (2) Date, duration and volume of discharge (estimate if unknown);
- (3) Description of the source (e.g., manhole, lift station);
- (4) Location of the discharge, by latitude and longitude (or other appropriate method as approved by the Department);
- (5) The ultimate destination of the flow (e.g., surface waterbody, municipal separate storm sewer to surface waterbody). Location should be shown on a USGS quad sheet or copy thereof; and
- (6) Corrective actions taken and/or planned to eliminate future discharges.

D. OTHER REPORTING AND NOTIFICATION REQUIREMENTS

1. Anticipated Noncompliance

The Permittee shall give the Director written advance notice of any planned changes or other circumstances regarding a facility which may result in noncompliance with permit requirements.

2. Termination of Discharge

The Permittee shall notify the Director, in writing, when all discharges from any point source(s) identified in Provision I. A. of this permit have permanently ceased. This notification shall serve as sufficient cause for instituting procedures for modification or termination of the permit.

3. Updating Information

- a. The Permittee shall inform the Director of any change in the Permittee's mailing address or telephone number or in the Permittee's designation of a facility contact or office having the authority and responsibility to prevent and abate violations of the AWPCA, the Department's Rules and the terms and conditions of this permit, in writing, no later than ten (10) days after such change. Upon request of the Director or his designee, the Permittee shall furnish the Director with an update of any information provided in the permit application.
- b. If the Permittee becomes aware that it failed to submit any relevant facts in a permit application, or submitted incorrect information in a permit application or in any report to the Director, it shall promptly submit such facts or information with a written explanation for the mistake and/or omission.

4. Duty to Provide Information

The Permittee shall furnish to the Director, within a reasonable time, any information which the Director or his designee may request to determine whether cause exists for modifying, revoking and re-issuing, suspending, or terminating this permit, in whole or in part, or to determine compliance with this permit.

E. SCHEDULE OF COMPLIANCE

1. Compliance with discharge limits

The Permittee shall achieve compliance with the discharge limitations specified in Provision I. A. in accordance with the following schedule:

COMPLIANCE SHALL BE ATTAINED ON THE EFFECTIVE DATE OF THIS PERMIT

2. Schedule

No later than 14 calendar days following a date identified in the above schedule of compliance, the permittee shall submit either a report of progress or, in the case of specific actions being required by identified dates, a written notice of compliance or noncompliance. In the latter case, the notice shall include the cause of noncompliance, any remedial actions taken, and the probability of meeting the next scheduled requirement.

PART II OTHER REQUIREMENTS, RESPONSIBILITIES, AND DUTIES

A. OPERATIONAL AND MANAGEMENT REQUIREMENTS

1. Facilities Operation and Maintenance

The Permittee shall at all times properly operate and maintain all facilities and systems of treatment and control (and related appurtenances) which are installed or used by the Permittee to achieve compliance with the conditions of the permit. Proper operation and maintenance includes effective performance, adequate funding, adequate operator staffing and training, and adequate laboratory and process controls, including appropriate quality assurance procedures. This provision requires the operation of backup or auxiliary facilities only when necessary to achieve compliance with the conditions of the permit.

2. Best Management Practices (BMP)

- a. Dilution water shall not be added to achieve compliance with discharge limitations except when the Director or his designee has granted prior written authorization for dilution to meet water quality requirements.
- b. The Permittee shall prepare, implement, and maintain a Spill Prevention, Control and Countermeasures (SPCC) Plan in accordance with 40 C.F.R. Section 112 if required thereby.
- c. The Permittee shall prepare, submit for approval and implement a BMP Plan for containment of any or all process liquids or solids, in a manner such that these materials do not present a significant potential for discharge, if so required by the Director or his designee. When submitted and approved, the BMP Plan shall become a part of this permit and all requirements of the BMP Plan shall become requirements of this permit.

3. Certified Operator

The Permittee shall not operate any wastewater treatment plant unless the competency of the operator to operate such plant has been duly certified by the Director pursuant to AWPCA, and meets the requirements specified in ADEM Administrative Code, Rule 335-10-1.

B. OTHER RESPONSIBILITIES

1. Duty to Mitigate Adverse Impacts

The Permittee shall promptly take all reasonable steps to mitigate and minimize or prevent any adverse impact on human health or the environment resulting from noncompliance with any discharge limitation specified in Provision I. A. of this permit, including such accelerated or additional monitoring of the discharge and/or the receiving waterbody as necessary to determine the nature and impact of the noncomplying discharge.

2. Right of Entry and Inspection

The Permittee shall allow the Director, or an authorized representative, upon the presentation of proper credentials and other documents as may be required by law to:

- (1) Enter upon the Permittee's premises where a regulated facility or activity or point source is located or conducted, or where records must be kept under the conditions of the permit;
- (2) Have access to and copy, at reasonable times, any records that must be kept under the conditions of the permits;
- (3) Inspect any facilities, equipment (including monitoring and control equipment), practices, or operations regulated or required under the permit; and
- (4) Sample or monitor, for the purposes of assuring permit compliance or as otherwise authorized by the AWPCA, any substances or parameters at any location.

C. BYPASS AND UPSET

1. Bypass

- a. Any bypass is prohibited except as provided in b. and c. below:
- b. A bypass is not prohibited if:
 - (1) It does not cause any discharge limitation specified in Provision I. A. of this permit to be exceeded;
 - (2) It enters the same receiving stream as the permitted outfall; and
 - (3) It is necessary for essential maintenance of a treatment or control facility or system to assure efficient operation of such facility or system.
- c. A bypass is not prohibited and need not meet the discharge limitations specified in Provision I. A. of this permit if:
 - (1) It is unavoidable to prevent loss of life, personal injury, or severe property damage;

- (2) There are no feasible alternatives to the bypass, such as the use of auxiliary treatment facilities, retention of untreated wastes, or maintenance during normal periods of equipment downtime (this condition is not satisfied if adequate back-up equipment should have been installed in the exercise of reasonable engineering judgment to prevent a bypass which occurred during normal periods of equipment downtime or preventive maintenance); and
 - (3) The Permittee submits a written request for authorization to bypass to the Director at least ten (10) days prior to the anticipated bypass (if possible), the Permittee is granted such authorization, and the Permittee complies with any conditions imposed by the Director to minimize any adverse impact on human health or the environment resulting from the bypass.
- d. The Permittee has the burden of establishing that each of the conditions of Provision II. C. 1. b. or c. have been met to qualify for an exception to the general prohibition against bypassing contained in a. and an exemption, where applicable, from the discharge limitations specified in Provision I. A. of this permit.

2. Upset

- a. A discharge which results from an upset need not meet the discharge limitations specified in Provision I. A. of this permit if:
- (1) No later than 24-hours after becoming aware of the occurrence of the upset, the Permittee orally reports the occurrence and circumstances of the upset to the Director or his designee; and
 - (2) No later than five (5) days after becoming aware of the occurrence of the upset, the Permittee furnishes the Director with evidence, including properly signed, contemporaneous operating logs, or other relevant evidence, demonstrating that:
 - (i) An upset occurred;
 - (ii) The Permittee can identify the specific cause(s) of the upset;
 - (iii) The Permittee's facility was being properly operated at the time of the upset; and
 - (iv) The Permittee promptly took all reasonable steps to minimize any adverse impact on human health or the environment resulting from the upset.
- b. The Permittee has the burden of establishing that each of the conditions of Provision II C. 2. a. of this permit have been met to qualify for an exemption from the discharge limitations specified in Provision I. A. of this permit.

D. DUTY TO COMPLY WITH PERMIT, RULES, AND STATUTES

1. Duty to Comply

- a. The Permittee must comply with all conditions of this permit. Any permit noncompliance constitutes a violation of the AWPCA and the FWPCA and is grounds for enforcement action, for permit termination, revocation and reissuance, suspension, modification, or denial of a permit renewal application.
- b. The necessity to halt or reduce production or other activities in order to maintain compliance with the conditions of the permit shall not be a defense for a Permittee in an enforcement action.
- c. The discharge of a pollutant from a source not specifically identified in the permit application for this permit and not specifically included in the description of an outfall in this permit is not authorized and shall constitute noncompliance with this permit.
- d. The Permittee shall take all reasonable steps, including cessation of production or other activities, to minimize or prevent any violation of this permit or to minimize or prevent any adverse impact of any permit violation.
- e. Nothing in this permit shall be construed to preclude or negate the Permittee's responsibility to apply for, obtain, or comply with other Federal, State, or Local Government permits, certifications, or licenses or to preclude from obtaining other federal, state, or local approvals, including those applicable to other ADEM programs and regulations.

2. Removed Substances

Solids, sludges, filter backwash, or any other pollutant or other waste removed in the course of treatment or control of wastewaters shall be disposed of in a manner that complies with all applicable Department Rules.

3. Loss or Failure of Treatment Facilities

Upon the loss or failure of any treatment facilities, including but not limited to the loss or failure of the primary source of power of the treatment facility, the Permittee shall, where necessary to maintain compliance with the discharge limitations specified in Provision I. A. of this permit, or any other terms or conditions of this permit, cease, reduce, or otherwise control production and/or all discharges until treatment is restored. If control of discharge during loss or failure of the

primary source of power is to be accomplished by means of alternate power sources, standby generators, or retention of inadequately treated effluent, the Permittee must furnish to the Director within six months a certification that such control mechanisms have been installed.

4. Compliance With Statutes and Rules

- a. This permit has been issued under ADEM Administrative Code, Chapter 335-6-6. All provisions of this chapter, that are applicable to this permit, are hereby made a part of this permit. A copy of this chapter may be obtained for a small charge from the Office of General Counsel, Alabama Department of Environmental Management, 1400 Coliseum Boulevard Montgomery, Alabama 36110-2059.
- b. This permit does not authorize the noncompliance with or violation of any Laws of the State of Alabama or the United States of America or any regulations or rules implementing such laws. FWPCA, 33 U.S.C. Section 1319, and Code of Alabama 1975, Section 22-22-14.

E. PERMIT TRANSFER, MODIFICATION, SUSPENSION, REVOCATION, AND REISSUANCE

1. Duty to Reapply or Notify of Intent to Cease Discharge

- a. If the Permittee intends to continue to discharge beyond the expiration date of this permit, the Permittee shall file a complete permit application for reissuance of this permit at least 180 days prior to its expiration. If the Permittee does not intend to continue discharge beyond the expiration of this permit, the Permittee shall submit written notification of this intent which shall be signed by an individual meeting the signatory requirements for a permit application as set forth in ADEM Administrative Code Rule 335-6-6-.09.
- b. Failure of the Permittee to apply for reissuance at least 180 days prior to permit expiration will void the automatic continuation of the expiring permit provided by ADEM Administrative Code Rule 335-6-6-.06 and should the permit not be reissued for any reason any discharge after expiration of this permit will be an unpermitted discharge.

2. Change in Discharge

Prior to any facility expansion, process modification or any significant change in the method of operation of the Permittee's treatment works, the Permittee shall provide the Director with information concerning the planned expansion, modification or change. The Permittee shall apply for a permit modification at least 180 days prior to any facility expansion, process modification, any significant change in the method of operation of the Permittee's treatment works or other actions that could result in the discharge of additional pollutants or increase the quantity of a discharged pollutant or could result in an additional discharge point. This condition applies to pollutants that are or that are not subject to discharge limitations in this permit. No new or increased discharge may begin until the Director has authorized it by issuance of a permit modification or a reissued permit.

3. Transfer of Permit

This permit may not be transferred or the name of the Permittee changed without notice to the Director and subsequent modification or revocation and reissuance of the permit to identify the new Permittee and to incorporate any other changes as may be required under the FWPCA or AWPCA. In the case of a change in name, ownership or control of the Permittee's premises only, a request for permit modification in a format acceptable to the Director is required at least 30 days prior to the change. In the case of a change in name, ownership or control of the Permittee's premises accompanied by a change or proposed change in effluent characteristics, a complete permit application is required to be submitted to the Director at least 180 days prior to the change. Whenever the Director is notified of a change in name, ownership or control, he may decide not to modify the existing permit and require the submission of a new permit application.

4. Permit Modification and Revocation

- a. This permit may be modified or revoked and reissued, in whole or in part, during its term for cause, including but not limited to, the following:
 - (1) If cause for termination under Provision II. E. 5. of this permit exists, the Director may choose to revoke and reissue this permit instead of terminating the permit;
 - (2) If a request to transfer this permit has been received, the Director may decide to revoke and reissue or to modify the permit; or
 - (3) If modification or revocation and reissuance is requested by the Permittee and cause exists, the Director may grant the request.
- b. This permit may be modified during its term for cause, including but not limited to, the following:
 - (1) If cause for termination under Provision II. E. 5. of this permit exists, the Director may choose to modify this permit instead of terminating this permit;

- (2) There are material and substantial alterations or additions to the facility or activity generating wastewater which occurred after permit issuance which justify the application of permit conditions that are different or absent in the existing permit;
- (3) The Director has received new information that was not available at the time of permit issuance and that would have justified the application of different permit conditions at the time of issuance;
- (4) A new or revised requirement(s) of any applicable standard or limitation is promulgated under Sections 301(b)(2)(C), (D), (E), and (F), and 307(a)(2) of the FWPCA;
- (5) Errors in calculation of discharge limitations or typographical or clerical errors were made;
- (6) To the extent allowed by ADEM Administrative Code, Rule 335-6-6-.17, when the standards or regulations on which the permit was based have been changed by promulgation of amended standards or regulations or by judicial decision after the permit was issued;
- (7) To the extent allowed by ADEM Administrative Code, Rule 335-6-6-.17, permits may be modified to change compliance schedules;
- (8) To agree with a granted variance under 301(c), 301(g), 301(h), 301(k), or 316(a) of the FWPCA or for fundamentally different factors;
- (9) To incorporate an applicable 307(a) FWPCA toxic effluent standard or prohibition;
- (10) When required by the reopener conditions in this permit;
- (11) When required under 40 CFR 403.8(e) (compliance schedule for development of pretreatment program);
- (12) Upon failure of the state to notify, as required by Section 402(b)(3) of the FWPCA, another state whose waters may be affected by a discharge permitted by this permit;
- (13) When required to correct technical mistakes, such as errors in calculation, or mistaken interpretations of law made in determining permit conditions; or
- (14) When requested by the Permittee and the Director determines that the modification has cause and will not result in a violation of federal or state law, regulations or rules.

5. Termination

This permit may be terminated during its term for cause, including but not limited to, the following:

- a. Violation of any term or condition of this permit;
- b. The Permittee's misrepresentation or failure to disclose fully all relevant facts in the permit application or during the permit issuance process or the Permittee's misrepresentation of any relevant facts at any time;
- c. Materially false or inaccurate statements or information in the permit application or the permit;
- d. A change in any condition that requires either a temporary or permanent reduction or elimination of the permitted discharge;
- e. The Permittee's discharge threatens human life or welfare or the maintenance of water quality standards;
- f. Permanent closure of the facility generating the wastewater permitted to be discharged by this permit or permanent cessation of wastewater discharge;
- g. New or revised requirements of any applicable standard or limitation that is promulgated under Sections 301(b)(2)(C), (D), (E), and (F), and 307(a)(2) of the FWPCA that the Director determines cannot be complied with by the Permittee; or
- h. Any other cause allowed by the ADEM Administrative Code, Chapter 335-6-6.

6. Suspension

This permit may be suspended during its term for noncompliance until the Permittee has taken action(s) necessary to achieve compliance.

7. Stay

The filing of a request by the Permittee for modification, suspension or revocation of this permit, in whole or in part, does not stay any permit term or condition.

F. COMPLIANCE WITH TOXIC POLLUTANT STANDARD OR PROHIBITION

If any applicable effluent standard or prohibition (including any schedule of compliance specified in such effluent standard or prohibition) is established under Section 307(a) of the FWPCA, 33 U.S.C. Section 1317(a), for a toxic pollutant discharged by the Permittee, and such standard or prohibition is more stringent than any discharge limitation on the pollutant specified in Provision I. A. of this permit or controls a pollutant not limited in Provision I. A. of this permit, this permit shall be modified to conform to the toxic pollutant effluent standard or prohibition, and the Permittee shall be notified of such modification. If this permit has not been modified to conform to the toxic pollutant effluent standard or prohibition before the effective date of such standard or prohibition, the Permittee shall attain compliance with the requirements of the standard or prohibition within the time period required by the standard or prohibition and shall continue to comply with the standard or prohibition until this permit is modified or reissued.

G. NOTICE TO DIRECTOR OF INDUSTRIAL USERS

1. The Permittee shall not allow the introduction of wastewater, other than domestic wastewater, from a new direct discharger prior to approval and permitting, if applicable, of the discharge by the Department.
2. The Permittee shall not allow an existing indirect discharger to increase the quantity or change the character of its wastewater, other than domestic wastewater, prior to approval and permitting, if applicable, of the increased discharge by the Department.
3. The Permittee shall report to the Department any adverse impact caused or believed to be caused by an indirect discharger on the treatment process, quality of discharged water, or quality of sludge. Such report shall be submitted within seven days of the Permittee becoming aware of the adverse impacts.

H. PROHIBITIONS

The Permittee shall not allow, and shall take effective enforcement action to prevent and terminate, the introduction of any of the following into its treatment works by industrial users:

1. Pollutants which create a fire or explosion hazard in the treatment works;
2. Pollutants which will cause corrosive structural damage to the treatment works, or dischargers with a pH lower than 5.0 s.u., unless the works are specifically designed to accommodate such discharges;
3. Solid or viscous pollutants in amounts which will cause obstruction of flow in sewers, or other interference with the treatment works;
4. Pollutants, including oxygen demanding pollutants, released in a discharge of such volume or strength as to cause interference in the treatment works;
5. Heat in amounts which will inhibit biological activity in the treatment plant resulting in interference or in such quantities that the temperature of the treatment plant influent exceeds 40°C (104° F) unless the treatment plant is designed to accommodate such heat; and
6. Pollutants in amounts which exceed any applicable pretreatment standard under Section 307 of FWPCA or any approved revisions thereof.

PART III ADDITIONAL REQUIREMENTS, CONDITIONS, AND LIMITATIONS

A. CIVIL AND CRIMINAL LIABILITY

1. Tampering

Any person who falsifies, tampers with, or knowingly renders inaccurate any monitoring device or method required to be maintained or performed under the permit shall, upon conviction, be subject to penalties as provided by the AWPCA.

2. False Statements

Any person who knowingly makes any false statement, representation, or certification in any record or other document submitted or required to be maintained under this permit, including monitoring reports or reports of compliance or noncompliance shall, upon conviction, be subject to penalties as provided by the AWPCA.

3. Permit Enforcement

- a. Any NPDES permit issued or reissued by the Department is a permit for the purpose of the AWPCA and the FWPCA, and as such, any terms, conditions, or limitations of the permit are enforceable under state and federal law.
- b. Any person required to have a NPDES permit pursuant to ADEM Administrative Code Chapter 335-6-6 and who discharges pollutants without said permit, who violates the conditions of said permit, who discharges pollutants in a manner not authorized by the permit, or who violates applicable orders of the Department or any applicable rule or standard of the Department, is subject to any one or combination of the following enforcement actions under applicable state statutes:
 - (1) An administrative order requiring abatement, compliance, mitigation, cessation, clean-up, and/or penalties;
 - (2) An action for damages;
 - (3) An action for injunctive relief; or
 - (4) An action for penalties.
- c. If the Permittee is not in compliance with the conditions of an expiring or expired permit the Director may choose to do any or all of the following provided the Permittee has made a timely and complete application for reissuance of the permit:
 - (1) Initiate enforcement action based upon the permit which has been continued;
 - (2) Issue a notice of intent to deny the permit reissuance. If the permit is denied, the owner or operator would then be required to cease the activities authorized by the continued permit or be subject to enforcement action for operating without a permit;
 - (3) Reissue the new permit with appropriate conditions; or
 - (4) Take other actions authorized by these rules and AWPCA.

4. Relief from Liability

Except as provided in Provision II. C. 1. (Bypass) and Provision II. C. 2. (Upset), nothing in this permit shall be construed to relieve the Permittee of civil or criminal liability under the AWPCA or FWPCA for noncompliance with any term or condition of this permit.

B. OIL AND HAZARDOUS SUBSTANCE LIABILITY

Nothing in this permit shall be construed to preclude the institution of any legal action or relieve the Permittee from any responsibilities, liabilities or penalties to which the Permittee is or may be subject under Section 311 of the FWPCA, 33 U.S.C. Section 1321.

C. PROPERTY AND OTHER RIGHTS

This permit does not convey any property rights in either real or personal property, or any exclusive privileges, nor does it authorize any injury to persons or property or invasion of other private rights, or any infringement of federal, state, or local laws or regulations, nor does it authorize or approve the construction of any physical structures or facilities or the undertaking of any work in any waters of the state or of the United States.

D. AVAILABILITY OF REPORTS

Except for data determined to be confidential under Code of Alabama 1975, Section 22-22-9(c), all reports prepared in accordance with the terms of this permit shall be available for public inspection at the offices of the Department. Effluent data shall not be considered confidential.

E. EXPIRATION OF PERMITS FOR NEW OR INCREASED DISCHARGES

1. If this permit was issued for a new discharger or new source, this permit shall expire eighteen months after the issuance date if construction of the facility has not begun during the eighteen-month period.
2. If this permit was issued or modified to allow the discharge of increased quantities of pollutants to accommodate the modification of an existing facility and if construction of this modification has not begun during the eighteen month period after issuance of this permit or permit modification, this permit shall be modified to reduce the quantities of pollutants allowed to be discharged to those levels that would have been allowed if the modification of the facility had not been planned.
3. Construction has begun when the owner or operator has:
 - a. Begun, or caused to begin as part of a continuous on-site construction program:
 - (1) Any placement, assembly, or installation of facilities or equipment; or
 - (2) Significant site preparation work including clearing, excavation, or removal of existing buildings, structures, or facilities which are necessary for the placement, assembly, or installation of new source facilities or equipment; or
 - b. Entered into a binding contractual obligation for the purpose of placement, assembly, or installation of facilities or equipment which are intended to be used in its operation within a reasonable time. Options to purchase or contracts which can be terminated or modified without substantial loss, and contracts for feasibility, engineering, and design studies do not constitute a contractual obligation under this paragraph.
4. Final plans and specifications for a waste treatment facility at a new source or new discharger, or a modification to an existing waste treatment facility must be submitted to and examined by the Department prior to initiating construction of such treatment facility by the Permittee.
5. Upon completion of construction of waste treatment facilities and prior to operation of such facilities, the Permittee shall submit to the Department a certification from a registered professional engineer, licensed to practice in the State of Alabama, that the treatment facilities have been built according to plans and specifications submitted to and examined by the Department.

F. COMPLIANCE WITH WATER QUALITY STANDARDS

1. On the basis of the Permittee's application, plans, or other available information, the Department has determined that compliance with the terms and conditions of this permit should assure compliance with the applicable water quality standards.
2. Compliance with permit terms and conditions notwithstanding, if the Permittee's discharge(s) from point sources identified in Provision I. A. of this permit cause or contribute to a condition in contravention of state water quality standards, the Department may require abatement action to be taken by the Permittee in emergency situations or modify the permit pursuant to the Department's Rules, or both.
3. If the Department determines, on the basis of a notice provided pursuant to this permit or any investigation, inspection or sampling, that a modification of this permit is necessary to assure maintenance of water quality standards or compliance with other provisions of the AWPCA or FWPCA, the Department may require such modification, and, in cases of emergency, the Director may prohibit the discharge until the permit has been modified.

G. GROUNDWATER

Unless specifically authorized under this permit, this permit does not authorize the discharge of pollutants to groundwater. Should a threat of groundwater contamination occur, the Director may require groundwater monitoring to properly assess the degree of the problem, and the Director may require that the Permittee undertake measures to abate any such discharge and/or contamination.

H. DEFINITIONS

1. Average monthly discharge limitation – means the highest allowable average of "daily discharges" over a calendar month, calculated as the sum of all "daily discharges" measured during a calendar month divided by the number of "daily discharges" measured during that month (zero discharge days shall not be included in the number of "daily discharges" measured and a less than detectable test result shall be treated as a concentration of zero if the most sensitive EPA approved method was used).
2. Average weekly discharge limitation - means the highest allowable average of "daily discharges" over a calendar week, calculated as the sum of all "daily discharges" measured during a calendar week divided by the number of "daily discharges" measured during that week (zero discharge days shall not be included in the number of "daily discharges" measured and a less than detectable test result shall be treated as a concentration of zero if the most sensitive EPA approved method was used).

3. Arithmetic Mean – means the summation of the individual values of any set of values divided by the number of individual values.
4. AWPCA – means the Alabama Water Pollution Control Act.
5. BOD – means the five-day measure of the pollutant parameter biochemical oxygen demand.
6. Bypass – means the intentional diversion of waste streams from any portion of a treatment facility.
7. CBOD – means the five-day measure of the pollutant parameter carbonaceous biochemical oxygen demand.
8. Daily discharge – means the discharge of a pollutant measured during any consecutive 24-hour period in accordance with the sample type and analytical methodology specified by the discharge permit.
9. Daily maximum – means the highest value of any individual sample result obtained during a day.
10. Daily minimum – means the lowest value of any individual sample result obtained during a day.
11. Day – means any consecutive 24-hour period.
12. Department – means the Alabama Department of Environmental Management.
13. Director – means the Director of the Department.
14. Discharge – means "[t]he addition, introduction, leaking, spilling or emitting of any sewage, industrial waste, pollutant or other waste into waters of the state". Code of Alabama 1975, Section 22-22-1(b)(9).
15. Discharge Monitoring Report (DMR) – means the form approved by the Director to accomplish reporting requirements of an NPDES permit.
16. DO – means dissolved oxygen.
17. 8HC – means 8-hour composite sample, including any of the following:
 - a. The mixing of at least 8 equal volume samples collected at constant time intervals of not more than 1 hour over a period of not less than 8 hours between the hours of 6:00 a.m. and 6:00 p.m. If the sampling period exceeds 8 hours, sampling may be conducted beyond the 6:00 a.m. to 6:00 p.m. period.
 - b. A sample continuously collected at a constant rate over period of not less than 8 hours between the hours of 6:00 a.m. and 6:00 p.m. If the sampling period exceeds 8 hours, sampling may be conducted beyond the 6:00 a.m. to 6:00 p.m. period.
18. EPA – means the United States Environmental Protection Agency.
19. FC – means the pollutant parameter fecal coliform.
20. Flow – means the total volume of discharge in a 24-hour period.
21. FWPCA – means the Federal Water Pollution Control Act.
22. Geometric Mean – means the Nth root of the product of the individual values of any set of values where N is equal to the number of individual values. The geometric mean is equivalent to the antilog of the arithmetic mean of the logarithms of the individual values. For purposes of calculating the geometric mean, values of zero (0) shall be considered one (1).
23. Grab Sample – means a single influent or effluent portion which is not a composite sample. The sample(s) shall be collected at the period(s) most representative of the discharge.
24. Indirect Discharger – means a nondomestic discharger who discharges pollutants to a publicly owned treatment works or a privately owned treatment facility operated by another person.
25. Industrial User – means those industries identified in the Standard Industrial Classification manual, Bureau of the Budget 1967, as amended and supplemented, under the category "Division D – Manufacturing" and such other classes of significant waste producers as, by regulation, the Director deems appropriate.
26. MGD – means million gallons per day.
27. Monthly Average – means the arithmetic mean of all the composite or grab samples taken for the daily discharges collected in one month period. The monthly average for flow is the arithmetic mean of all flow measurements taken in a one month period.
28. New Discharger – means a person, owning or operating any building, structure, facility or installation:
 - a. From which there is or may be a discharge of pollutants;
 - b. From which the discharge of pollutants did not commence prior to August 13, 1979, and which is not a new source; and

- c. Which has never received a final effective NPDES permit for dischargers at that site.
29. NH3-N – means the pollutant parameter ammonia, measured as nitrogen.
30. Notifiable sanitary sewer overflow – means an overflow, spill, release or diversion of wastewater from a sanitary sewer system that:
- Reaches a surface water of the State; or
 - May imminently and substantially endanger human health based on potential for public exposure including but not limited to close proximity to public or private water supply wells or in areas where human contact would be likely to occur.
31. Permit application – means forms and additional information that is required by ADEM Administrative Code Rule 335-6-6-.08 and applicable permit fees.
32. Point source – means "any discernible, confined and discrete conveyance, including but not limited to any pipe, channel, ditch, tunnel, conduit, well, discrete fissure, container, rolling stock, concentrated animal feeding operation, or vessel or other floating craft, . . . from which pollutants are or may be discharged." Section 502(14) of the FWPCA, 33 U.S.C. Section 1362(14).
33. Pollutant – includes for purposes of this permit, but is not limited to, those pollutants specified in Code of Alabama 1975, Section 22-22-1(b)(3) and those effluent characteristics specified in Provision I. A. of this permit.
34. Privately Owned Treatment Works – means any devices or system which is used to treat wastes from any facility whose operator is not the operator of the treatment works, and which is not a "POTW".
35. Publicly Owned Treatment Works – means a wastewater collection and treatment facility owned by the State, municipality, regional entity composed of two or more municipalities, or another entity created by the State or local authority for the purpose of collecting and treating municipal wastewater.
36. Receiving Stream – means the "waters" receiving a "discharge" from a "point source".
37. Severe property damage – means substantial physical damage to property, damage to the treatment facilities which causes them to become inoperable, or substantial and permanent loss of natural resources which can reasonably be expected to occur in the absence of a bypass. Severe property damage does not mean economic loss caused by delays in production.
38. Significant Source – means a source which discharges 0.025 MGD or more to a POTW or greater than five percent of the treatment work's capacity, or a source which is a primary industry as defined by the U.S. EPA or which discharges a priority or toxic pollutant.
39. TKN – means the pollutant parameter Total Kjeldahl Nitrogen.
40. TON – means the pollutant parameter Total Organic Nitrogen.
41. TRC – means Total Residual Chlorine.
42. TSS – means the pollutant parameter Total Suspended Solids.
43. 24HC – means 24-hour composite sample, including any of the following:
- The mixing of at least 8 equal volume samples collected at constant time intervals of not more than 2 hours over a period of 24 hours;
 - A sample collected over a consecutive 24-hour period using an automatic sampler composite to one sample. As a minimum, samples shall be collected hourly and each shall be no more than one twenty-fourth (1/24) of the total sample volume collected; or
 - A sample collected over a consecutive 24-hour period using an automatic composite sampler composited proportional to flow.
44. Upset – means an exceptional incident in which there is an unintentional and temporary noncompliance with technology-based permit discharge limitations because of factors beyond the reasonable control of the Permittee. An upset does not include noncompliance to the extent caused by operational error, improperly designed treatment facilities, inadequate treatment facilities, lack of preventive maintenance, or careless or improper operation.
45. Waters – means "[a]ll waters of any river, stream, watercourse, pond, lake, coastal, ground, or surface water, wholly or partially within the state, natural or artificial. This does not include waters which are entirely confined and retained completely upon the property of a single individual, partnership, or corporation unless such waters are used in interstate commerce." Code of Alabama 1975, Section 22-22-1(b)(2). Waters "include all navigable waters" as defined in Section 502(7) of the FWPCA, 22 U.S.C. Section 1362(7), which are within the State of Alabama.
46. Week – means the period beginning at twelve midnight Saturday and ending at twelve midnight the following Saturday.

47. Weekly (7-day and calendar week) Average – is the arithmetic mean of all samples collected during a consecutive 7-day period or calendar week, whichever is applicable. The calendar week is defined as beginning on Sunday and ending on Saturday. Weekly averages shall be calculated for all calendar weeks with Saturdays in the month. If a calendar week overlaps two months (i.e., the Sunday is in one month and the Saturday in the following month), the weekly average calculated for the calendar week shall be included in the data for the month that contains the Saturday.

I. SEVERABILITY

The provisions of this permit are severable, and if any provision of this permit or the application of any provision of this permit to any circumstance is held invalid, the application of such provision to other circumstances, and the remainder of this permit, shall not be affected thereby.

PART IV SPECIFIC REQUIREMENTS, CONDITIONS, AND LIMITATIONS

A. SLUDGE MANAGEMENT PRACTICES

1. Applicability
 - a. Provisions of Provision IV.A. apply to a sewage sludge generated or treated in treatment works that is applied to agricultural and non-agricultural land, or that is otherwise distributed, marketed, incinerated, or disposed in landfills or surface disposal sites.
 - b. Provisions of Provision IV.A. do not apply to:
 - (1) Sewage sludge generated or treated in a privately owned treatment works operated in conjunction with industrial manufacturing and processing facilities and which receive no domestic wastewater.
 - (2) Sewage sludge that is stored in surface impoundments located at the treatment works prior to ultimate disposal.
2. Submitting Information
 - a. If applicable, the Permittee must submit annually with its Municipal Water Pollution Prevention (MWPP) report the following:
 - (1) Type of sludge stabilization/digestion method;
 - (2) Daily or annual sludge production (dry weight basis);
 - (3) Ultimate sludge disposal practice(s).
 - b. The Permittee shall provide sludge inventory data to the Director as requested. These data may include, but are not limited to, sludge quantity and quality reported in Provision IV.A.2.a as well as other specific analyses required to comply with State and Federal laws regarding solid and hazardous waste disposal.
 - c. The Permittee shall give prior notice to the Director of at least 30 days of any change planned in the Permittee's sludge disposal practices.
3. Reopener or Modification
 - a. Upon review of information provided by the Permittee as required by Provision IV.A.2. or, based on the results of an on-site inspection, the permit shall be subject to modification to incorporate appropriate requirements.
 - b. If an applicable "acceptable management practice" or if a numerical limitation for a pollutant in sewage sludge promulgated under Section 405 of FWPCA is more stringent than the sludge pollutant limit or acceptable management practice in this permit. This permit shall be modified or revoked or reissued to conform to requirements promulgated under Section 405. The Permittee shall comply with the limitations no later than the compliance deadline specified in applicable regulations as required by Section 405 of FWPCA.

B. EFFLUENT TOXICITY TESTING REOPENER

Upon notification under Part II.G. of any newly introduced toxic industrial wastewaters, the Director may reopen the permit to include effluent toxicity limitations and testing requirements.

C. TOTAL RESIDUAL CHLORINE (TRC) REQUIREMENTS

1. If chlorine is not utilized for disinfection purposes, TRC monitoring under Part I of this Permit is not required. If TRC monitoring is not required (conditional monitoring), "*9" or "NODI = 9" (if hard copy) should be reported on the DMR forms.
2. Testing for TRC shall be conducted according to either the amperometric titration method or the DPD colorimetric method as specified in Section 408(C) or (E), Standards Methods for the Examination of Water and Wastewater, 18th edition. If chlorine is not detected prior to actual discharge to the receiving stream using one of these methods (i.e., the analytical result is less than the detection level), the Permittee shall report on the DMR form "*B", "NODI = B" (if hard copy), or "0". The Permittee shall then be considered to be in compliance with the daily maximum concentration limit for TRC.
3. This permit contains a maximum allowable TRC level in the effluent. The Permittee is responsible for determining the minimum TRC level needed in the chlorine contact chamber to comply with E.coli limits. The effluent shall be dechlorinated if necessary to meet the maximum allowable effluent TRC level.
4. The sample collection point for effluent TRC shall be at a point downstream of the chlorine contact chamber (downstream of dechlorination if applicable). The exact location is to be approved by the Director.

D. PLANT CLASSIFICATION

The Permittee shall report to the Director within 30 days of the effective date of this permit, the name, address and operator number of the certified wastewater operator in responsible charge of the facility. Unless specified elsewhere in this permit, this facility shall be classified in accordance with ADEM Admin. Code R. 335-10-1-.03.

E. SANITARY SEWER OVERFLOW RESPONSE PLAN

1. SSO Response Plan

Within 120 days of the effective date of this Permit, the Permittee shall develop a Sanitary Sewer Overflow (SSO) Response Plan to establish timely and effective methods for responding to notifiable sanitary sewer overflows. The SSO Response Plan shall address each of the following:

a. General Information:

- (1) Approximate population of City/Town, if applicable
- (2) Approximate number of customers served by the Permittee
- (3) Identification of any subbasins designated by the Permittee, if applicable
- (4) Identification of estimated linear feet of sanitary sewers
- (5) Number of Pump/Lift Stations in the collection system

b. Responsibility Information:

- (1) The title(s) and contact information of key position(s) who will coordinate the SSO response, including information for a backup coordinator in the event that the primary SSO coordinator is unavailable. The SSO coordinator is the person responsible for assessing the SSO and initiating a series of response actions based on the type, severity, and destination of the SSO, except for routine SSOs for which the coordinator may pre-approve written procedures. Routine SSOs are those for which the corrective action procedures are generally consistent.
- (2) The title(s), and contact information of key position(s) who will respond to SSOs, including information for backup responder(s) in the event the primary responder(s) are unavailable (i.e., position(s) who provide notification to the Department, the public, the county health department, and other affected entities such as public water systems; position(s) responsible for organizing crews for response; position(s) responsible for addressing public inquiries)

c. SSO and Surface Water Assessment

- (1) Identification of locations within the collection system at which an SSO is likely to occur (e.g., based upon historical SSOs, lift stations where electricity may be lost, etc.)
- (2) A map of the general collection system area, including identification of surface waterbodies and the location(s) of public drinking water source(s). Mapping of all collection system piping, pump stations, etc. is not required; however, if this information is already available, it should be included.
- (3) Identification of surface waterbodies within the collection system area which are classified as Swimming according to ADEM Admin. Code chap. 335-6-11. References available to assist in this requirement include: <http://www.adem.alabama.gov/alEnviroRegLaws/files/Division6Vol1.pdf> and http://gis.adem.alabama.gov/ADEM_Dash/use_class/index.html
- (4) Identification of surface waterbodies within the collection system area which are not classified as Swimming as indicated in paragraph c above, but are known locally as areas where swimming occurs or as areas that are heavily recreated

d. Public Reporting of SSOs

- (1) Contact information for the public to report an SSO to the Permittee, during both normal and outside of normal business hours (e.g., telephone number, website, email address, etc.)

- (2) Information requested from the person reporting an SSO to assist the Permittee in identifying the SSO (e.g., date, time, location, contact information)
 - (3) Procedures for communication of the SSO report to the appropriate positions for follow-up investigation and response, if necessary
 - e. Procedures to immediately notify the Department, the county health department, and other affected entities (such as public water systems) upon becoming aware of notifiable SSOs
 - f. Public Notification Methods for SSOs
 - (1) A listing of methods that are feasible, as determined by the Permittee, for public notifications (e.g., flyers distributed to nearby residents; signs posted at the location of the SSO, where the SSO enters a water of the state, and/or at a central public location; signs posted at fishing piers, boat launches, parks, swimming waterbodies, etc.; website and/or social media notifications; local print or radio and broadcast media notifications; "opt in" email, text message, or automated phone message notifications)
 - (a) If signage is a feasible method for public notification, procedures for use and removal of signage (e.g., availability and maintenance of signs, appropriate duration of postings)
 - (2) Minimum information to be included in public notifications (e.g., identification that an SSO has occurred, date, duration if known, estimated volume if known, location of the SSO by street address or other appropriate method, initial destination of the SSO)
 - (3) Procedures developed by the Permittee for determining the appropriate public notification method(s) based upon the potential for public exposure to health risks associated with the SSO
 - g. Standard Procedures shall be developed by the Permittee and shall include, at a minimum:
 - (1) General SSO Response Procedures (e.g., procedures for dispatching staff to assess/correct an SSO; procedures for routine SSO corrective actions such as those for sewer blockages, overflowing manholes, line breakages, pump station power failure, etc.; procedures for disinfection of affected area, if applicable);
 - (2) Procedures for collection and proper disposal of the SSO, if feasible.
 - (3) General procedures for coordinating instream water quality monitoring, including, but not limited to, procedures for mobilizing staff, collecting samples, and typical test methods should the Department or the Permittee determine monitoring is appropriate following an SSO. Identification of a contractor who will collect and analyze the sample(s) may be listed in lieu of the procedures.
 - (4) References to other documents (such as Standard Operating Procedures for SSO Responses) may be acceptable for this section; however, the referenced document shall be identified and shall be reviewed at a frequency of at least that required by the Administrative Procedures Section.
 - h. Date of the SSO Response Plan, dates of all modifications and/or reviews, the title and signature of the reviewer(s) for each date and the signature of the responsible official or the appropriate designee.
2. SSO Response Plan Implementation

Except as otherwise required by this Permit, the Permittee shall fully implement the SSO Response Plan as soon as practicable, but no later than 180 days after the effective date of this Permit.
3. Department Review of the SSO Response Plan
 - a. When requested by the Director or his designee, the Permittee shall make the SSO Response Plan available for review by the Department.
 - b. Upon review, the Director or his designee may notify the Permittee that the SSO Response Plan is deficient and require modification of the Plan.
 - c. Within thirty days of receipt of notification, or an alternate timeframe as approved by the Department, the Permittee shall modify any SSO Response Plan deficiency identified by the Director or his designee and shall certify to the Department that the modification has been made.
4. SSO Response Plan Administrative Procedures

- a. The Permittee shall maintain a copy of the SSO Response Plan at the permitted facility or an alternate location approved by the Department in writing and shall make it available for inspection by the Department.
- b. The Permittee shall make a copy of the SSO Response Plan available to the public upon written request within 30 days of such request. The Permittee may redact information which may present security issues, such as location of public water supplies, identification of specific details of vulnerabilities, employee information, etc.
- c. The Permittee shall provide training for any personnel required to implement the SSO Response Plan and shall retain at the facility documentation of such training. This documentation shall be available for inspection by the Department. Training shall be provided for existing personnel prior to the date by which implementation of the SSO Response Plan is required and for new personnel as soon as possible. Should significant revisions be made to the SSO Response Plan, training regarding the revisions shall be conducted as soon as possible.
- d. The Permittee shall complete a review and evaluation of the SSO Response Plan at least once every three years. Documentation of the SSO Response Plan review and evaluation shall be signed and dated by the responsible official or the appropriate designee as part of the SSO Response Plan.

NPDES PERMIT RATIONALE

NPDES Permit No: **AL0082848** Date: January 5, 2021

Permit Applicant: Utilities Board of the Town of Gilbertown
13217 Choctaw Ave
Gilbertown, Alabama 36908

Location: Gilbertown Water Resources Recovery Facility
13217 Choctaw Ave
Gilbertown, Alabama 36908

Draft Permit is: Initial Issuance:
Reissuance due to expiration: X
Modification of existing permit:
Revocation and Reissuance:

Basis for Limitations: Water Quality Model: CBOD₅, NH₃-N
Reissuance with no modification: CBOD₅, CBOD₅ % Removal, NH₃-N,
pH, TRC, TSS, TSS % Removal
Instream calculation at 7Q10: 5%
Toxicity based: TRC
Secondary Treatment Levels: CBOD₅, CBOD₅ % Removal, TSS, TSS
% Removal
Other (described below): E. Coli, pH

Design Flow in Million Gallons per Day: 0.06 MGD

Major: No

Description of Discharge: Outfall Number 001; Effluent discharge to Okatuppa
Creek, which is classified as Fish and Wildlife

Discussion:

This is a permit reissuance due to expiration. In this reissuance, the facility location has been updated to reflect the current address. Limits for Five Day Carbonaceous Biochemical Oxygen Demand (CBOD₅) and Total Ammonia-Nitrogen (NH₃-N) were developed based on a Waste Load Allocation (WLA) model that was completed by ADEM's Water Quality Branch (WQB) on November 5, 2020. The monthly average limits for CBOD₅ and NH₃-N are 25.0 mg/L and 20 mg/L respectively. The daily minimum Dissolved Oxygen (DO) is to be monitored and reported.

The pH daily minimum and daily maximum limits of 6.0 and 9.0 S.U, respectively, were developed to be supportive of the water-use classification of the receiving stream. The Total Residual Chlorine (TRC) limits of 0.22 mg/L (monthly average) and 0.38 mg/L (daily maximum) are based on EPA's recommended water quality values and on the current Toxicity Rationale, which considers the available dilution in the receiving stream.

The Department revised bacteriological criteria in ADEM Administrative Code R.335-6-10-.09. As a result, this permit includes E. coli limits and seasons that are consistent with the revised regulations. The imposed E. coli limits were determined based on the water-use classification of the receiving stream. Since Okatuppa Creek is classified as Fish & Wildlife, the limits for May – October are 126 col/100ml (monthly average) and 298 col/100ml (daily maximum), while the limits for November – April are 548 col/100ml (monthly average) and 2507 col/100ml (daily maximum).

The Total Suspended Solids (TSS) and TSS % removal limits of 30.0 mg/L monthly average and 85.0%, respectively, are based on the requirements of 40 CFR part 133.102 regarding Secondary Treatment. A minimum percent removal limit of 85.0% is imposed for CBOD₅ in accordance with 40 CFR 133.102 regarding Secondary Treatment.

This permit requires the Permittee to monitor and report during the summer (April-October) the nutrient-related parameters of Total Kjeldahl Nitrogen (TKN), Nitrate plus Nitrite Nitrogen (N₀₂+N₀₃-N) and Total Phosphorus (TP). Monitoring for these nutrient related parameters is imposed so that sufficient information will be available regarding the nutrient contribution from this point source, should it be necessary at some later time to impose nutrient limits on this discharge.

Because this is a minor facility (design capacity less than 1 MGD) treating only domestic wastewater with no industrial wastewater contributions, no potential toxicity concerns are anticipated and thus there is no need to impose chronic or acute bioassay testing under this permit.

The monitoring frequency for CBOD₅, DO, E. Coli, NH₃-N, pH, TRC, and TSS is twice per month. The monitoring frequency for TKN, N₀₂+N₀₃-N and TP is once per month during the April through October summer growing season. CBOD₅ % removal TSS % removal and are to be calculated once per month. Flow is to be measured instantaneously on discharge days.

Okatuppa Creek is a Tier II stream and is not listed on the most recent 303(d) list. There are no Total Daily Maximum Daily Loads (TMDLs) affecting this discharge.

ADEM Administrative Rule 335-6-10-.12 requires applicants for new or expanded discharges to Tier II waters demonstrate that the proposed discharge is necessary for important economic or social development in the area in which the waters are located. The application submitted by the facility is not for a new or expanded discharge to a Tier II water body, so the applicant is not required to demonstrate that the discharge is necessary for economic and social development.

Prepared by: Michael Simmons

TOXICITY AND DISINFECTION RATIONALE

Facility Name:	Gilbertown Water Resources Recovery Facility	
NPDES Permit Number:	AL0082848	
Receiving Stream:	Okatuppa Creek	
Facility Design Flow (Q _w):	0.060 MGD	
Receiving Stream 7Q ₁₀ :	1.800 cfs	
Receiving Stream 1Q ₁₀ :	1.350 cfs	
Winter Headwater Flow (WHF):	9.10 cfs	
Summer Temperature for CCC:	30 deg. Celsius	
Winter Temperature for CCC:	20 deg. Celsius	
Headwater Background NH ₃ -N Level:	0.11 mg/l	
Receiving Stream pH:	7.0 s.u.	
Headwater Background FC Level (summer):	N/A.	(Only applicable for facilities with diffusers.)
(winter):	N/A.	

The Stream Dilution Ration (SDR) is calculated using the 7Q₁₀ for all stream classifications.

$$\text{Stream Dilution Ration (SDR)} = \frac{Q_w}{7Q_{10} + Q_w} = 4.90\%$$

AMMONIA TOXICITY LIMITATIONS

Toxicity-based ammonia limits are calculated in accordance with the *Ammonia Toxicity Protocol* and the *General Guidance for Writing Water Quality Based Toxicity Permits*.

If the Limiting Dilution is less than 1%, the waterbody is considered stream-dominated and the CMC applies.

If the Limiting Dilution is greater than 1%, the waterbody is considered effluent-dominated and the CCC applies.

$$\begin{aligned} \text{Limiting Dilution} &= \frac{Q_w}{7Q_{10} + Q_w} \\ &= 4.90\% \quad \text{Effluent-Dominated, CCC Applies} \end{aligned}$$

$$\begin{aligned} \text{Criterion Maximum Concentration (CMC):} & \quad \text{CMC} = 0.411 / (1 + 10^{(7.204 - \text{pH})}) + 58.4 / (1 + 10^{(\text{pH} - 7.204)}) \\ \text{Criterion Continuous Concentration (CCC):} & \quad \text{CCC} = [0.0577 / (1 + 10^{(7.688 - \text{pH})}) + 2.487 / (1 + 10^{(\text{pH} - 7.688)})] * \text{Min}[2.85, 1.45 * 10^{(0.028 * (25 - T))}] \end{aligned}$$

	<u>CMC</u>	<u>CCC</u>
Allowable Summer Instream NH ₃ -N:	36.09 mg/l	2.18 mg/l
Allowable Winter Instream NH ₃ -N:	36.09 mg/l	4.15 mg/l

$$\begin{aligned} \text{Summer NH}_3\text{-N Toxicity Limit} &= \frac{[(\text{Allowable Instream NH}_3\text{-N}) * (7Q_{10} + Q_w)] - [(\text{Headwater NH}_3\text{-N}) * (7Q_{10})]}{Q_w} \\ &= 42.3 \text{ mg/l NH}_3\text{-N at 7Q}_{10} \end{aligned}$$

$$\begin{aligned} \text{Winter NH}_3\text{-N Toxicity Limit} &= \frac{[(\text{Allowable Instream NH}_3\text{-N}) * (\text{WHF} + Q_w)] - [(\text{Headwater NH}_3\text{-N}) * (\text{WHF})]}{Q_w} \\ &= 400.2 \text{ mg/l NH}_3\text{-N at Winter Flow} \end{aligned}$$

The ammonia limits established in the permit will be the lesser of the DO-based ammonia limit (from the wasteload allocation model) or the toxicity limits calculated above.

	<u>DO-based NH₃-N limit</u>	<u>Toxicity-based NH₃-N limit</u>
Summer	20.00 mg/l NH₃-N	42.30 mg/l NH₃-N
Winter	20.00 mg/l NH₃-N	400.20 mg/l NH₃-N

Summer: The DO based limit of 20.00 mg/l NH₃-N applies.

Winter: The DO based limit of 20.00 mg/l NH₃-N applies.

TOXICITY TESTING REQUIREMENTS (REFERENCE: MUNICIPAL BRANCH TOXICITY PERMITTING STRATEGY)

The following factors trigger toxicity testing requirements:

1. Facility design flow is equal to or greater than 1.0 MGD (major facility).
2. There are significant industrial contributors (SID permits).

Acute toxicity testing is specified for A&I receiving streams, or for stream dilution ratios of 1% or less.

Chronic toxicity testing is specified for all other situations requiring toxicity testing.

This is a minor facility (Qw < 1.0 MGD) with no SID permits. No toxicity testing is required.

$$\text{Instream Waste Concentration (IWC)} = \frac{Q_w}{7Q_{10} + Q_w} = 4.90\% \quad \text{Note: This number will be rounded up for toxicity testing purposes.}$$

DISINFECTION REQUIREMENTS

Bacteria limits are required, and will be the water quality limit for the receiving stream, except where diffusers are used the limit may be adjusted for the dilution provided by the diffuser.

See the attached Disinfection Guidance for applicable stream standards.

(Non-coastal limits apply)

Applicable Stream Classification: **Fish & Wildlife**

Disinfection Type: **Chlorination**

Limit calculation method: **Limits based on meeting stream standards at the point of discharge.**

	Stream Standard (colonies/100ml)	Effluent Limit (colonies/100ml)
<u>E. Coli (applies to Non-coastal and Shellfish Harvesting Coastal)</u>		
Monthly limit as monthly average (November through April):	548	548
Monthly limit as monthly average (May through October):	126	126
Daily Max (November through April):	2507	2507
Daily Max (May through October):	298	298
<u>Enterococci (applies to Coastal)</u>		
Monthly limit as geometric mean (November through April):	Not applicable	Not applicable
Monthly limit as geometric mean (May through October):	Not applicable	Not applicable
Daily Max (November through April):	Not applicable	Not applicable
Daily Max (May through October):	Not applicable	Not applicable

MAXIMUM ALLOWABLE CHLORINATION LIMITS

Toxicity-based chlorine limits are calculated in accordance with the General Guidance for Writing Water Quality Based Toxicity Permits.

Chlorine has been shown to be acutely toxic at 0.019 mg/l and chronically toxic at 0.011 mg/l.

Maximum allowable TRC in effluent:	0.224 mg/l (chronic)	(0.011)/(SDR)
Maximum allowable TRC in effluent:	0.387 mg/l (acute)	(0.019)/(SDR)

NOTE: A maximum chlorine limit will be imposed such that the instream concentration will not exceed acutely toxic concentrations in A & I streams and chronically toxic concentrations in all other streams, but may not exceed 1.0 mg/l.

Prepared By: Michael Simmons Date: 12/14/2020

Waste Load Allocation Summary

Page 1

REQUEST INFORMATION

Request Number: 3728

From: Michael Simmons In Branch/Section: Municipal
Date Submitted: 9/16/2020 Date Required: 10/16/2020 FUND Code: 605
Date Permit application received by NPDES program: 3/12/2020

Receiving Waterbody: Okatuppa Creek
Previous Stream Name:
Facility Name: Gilbertown Water Resources Recovery Facility (Name of Discharger-WQ will use to file)
Previous Discharger Name:

River Basin: Tombigbee Outfall Latitude: 31.891700 (decimal degrees)
*County: Choctaw Outfall Longitude: -88.312840 (decimal degrees)

Permit Number: AL0082848 Permit Type: Permit Reissuance
Permit Status: Active
Type of Discharger: MUNICIPAL

Do other discharges exist that may impact the model? Yes No

If yes, impacting dischargers names.

Impacting dischargers permit numbers.

Existing Discharge Design Flow: 0.06 MGD
Proposed Discharge Design Flow: MGD

Note: The flow rates given should be those requested for modeling.

Comments included

Yes No

Information Verified By: JBR

Year File Was Created: 2009

Response ID Number: 1788

Lat/Long Method: GPS

12 Digit HUC Code: 031602010806

Use Classification: F&W

Site Visit Completed? Yes No

Date of Site Visit: 9/25/2020

Waterbody Impaired? Yes No

Date of WLA Response: 11/17/2020

Antidegradation Yes No

Approved TMDL?

Yes No

Waterbody Tier Level: Tier II

Approval Date of TMDL:

Use Support Category: 1

Waste Load Allocation Information

Modeled Reach Length: 11.99 Miles

Date of Allocation: 11/5/2020

Name of Model Used: SWQM

Allocation Type: 2 Seasons

Model Completed by: JBR

Type of Model Used: Desk-top

Allocation Developed by: Water Quality Branch

Waste Load Allocation Summary

Annual Effluent Limits	Conventional Parameters				Other Parameters			
	Qw	0.06	MGD	MGD	Qw	0.06	MGD	MGD
Season	Summer		Season	Winter		Season		
From	May		From	Dec		From		
Through	Nov		Through	Apr		Through		
CBOD5			CBOD5	25	mg/L	CBOD5	25	mg/L
NH3-N			NH3-N	20	mg/L	NH3-N	20	mg/L
TKN			TKN			TKN		
D.O.			D.O.	0	mg/L	D.O.	0	mg/L

"Monitor Only" Parameters for Effluent:	Parameter	Frequency	Parameter	Frequency
	TKN	Monthly(Apr-Oct)		
	NO2+NO3-N	Monthly(Apr-Oct)		
	TP	Monthly(Apr-Oct)		

Water Quality Characteristics Immediately Upstream of Discharge				
Parameter	Summer		Winter	
CBODu	2	mg/l	2	mg/l
NH3-N	0.11	mg/l	0.11	mg/l
Temperature	30	°C	20	°C
pH	7	su	7	su

Hydrology at Discharge Location		
Drainage Area	148	sq mi
Stream 7Q10	1.8	cfs
Stream 1Q10	1.35	cfs
Stream 7Q2	9.1	cfs
Annual Average	236.8	cfs

Method Used to Calculate
ADEM Estimate w/USGS Gage Data
75% of 7Q10
ADEM Estimate w/USGS Gage Data

Drainage Area Qualifier
Exact

Comments and/or Notations

EPA Identification Number	NPDES Permit Number AL0082848	Facility Name Gilbertown WRRF
---------------------------	----------------------------------	----------------------------------



Form 2A NPDES		U.S. Environmental Protection Agency Application for NPDES Permit to Discharge Wastewater NEW AND EXISTING PUBLICLY OWNED TREATMENT WORKS
---------------------	--	--

SECTION 1. BASIC APPLICATION INFORMATION FOR ALL APPLICANTS (40 CFR 122.21(j)(1) and (9))

Facility Information	1.1	Facility name Gilbertown Water Resources Recovery Facility		
		Mailing address (street or P.O. box) 13217 Choctaw Avenue		
		City or town Gilbertown	State Alabama	ZIP code 36908
		Contact name (first and last) Billy May	Title Chairman	Phone number (251) 743-2766
		Email address kweiss@gilbertownutilities.com		
		Location address (street, route number, or other specific identifier) <input checked="" type="checkbox"/> Same as mailing address		
		City or town	State	ZIP code
	1.2	Is this application for a facility that has yet to commence discharge? <input type="checkbox"/> Yes → See instructions on data submission requirements for new dischargers. <input checked="" type="checkbox"/> No		
Applicant Information	1.3	Is applicant different from entity listed under Item 1.1 above? <input type="checkbox"/> Yes <input checked="" type="checkbox"/> No → SKIP to Item 1.4.		
		Applicant name		
		Applicant address (street or P.O. box)		
		City or town	State	ZIP code
		Contact name (first and last)	Title	Phone number
		Email address		
	1.4	Is the applicant the facility's owner, operator, or both? (Check only one response.) <input type="checkbox"/> Owner <input type="checkbox"/> Operator <input checked="" type="checkbox"/> Both		
	1.5	To which entity should the NPDES permitting authority send correspondence? (Check only one response.) <input type="checkbox"/> Facility <input type="checkbox"/> Applicant <input checked="" type="checkbox"/> Facility and applicant (they are one and the same)		
Existing Environmental Permits	1.6	Indicate below any existing environmental permits. (Check all that apply and print or type the corresponding permit number for each.)		
		Existing Environmental Permits		
		<input checked="" type="checkbox"/> NPDES (discharges to surface water) AL0082848	<input type="checkbox"/> RCRA (hazardous waste)	<input type="checkbox"/> UIC (underground injection control)
		<input type="checkbox"/> PSD (air emissions)	<input type="checkbox"/> Nonattainment program (CAA)	<input type="checkbox"/> NESHAPs (CAA)
	<input type="checkbox"/> Ocean dumping (MPRSA)	<input type="checkbox"/> Dredge or fill (CWA Section 404)	<input type="checkbox"/> Other (specify)	

Collection System and Population Served	1.7	Provide the collection system information requested below for the treatment works.				
		Municipality Served	Population Served	Collection System Type (indicate percentage)		Ownership Status
		Gilbertown	187	<u>100</u> % separate sanitary sewer	<input checked="" type="checkbox"/> Own	<input checked="" type="checkbox"/> Maintain
				<u> </u> % combined storm and sanitary sewer	<input type="checkbox"/> Own	<input type="checkbox"/> Maintain
				<input type="checkbox"/> Unknown	<input type="checkbox"/> Own	<input type="checkbox"/> Maintain
				<u> </u> % separate sanitary sewer	<input type="checkbox"/> Own	<input type="checkbox"/> Maintain
				<u> </u> % combined storm and sanitary sewer	<input type="checkbox"/> Own	<input type="checkbox"/> Maintain
				<input type="checkbox"/> Unknown	<input type="checkbox"/> Own	<input type="checkbox"/> Maintain
			<u> </u> % separate sanitary sewer	<input type="checkbox"/> Own	<input type="checkbox"/> Maintain	
			<u> </u> % combined storm and sanitary sewer	<input type="checkbox"/> Own	<input type="checkbox"/> Maintain	
			<input type="checkbox"/> Unknown	<input type="checkbox"/> Own	<input type="checkbox"/> Maintain	
			<u> </u> % separate sanitary sewer	<input type="checkbox"/> Own	<input type="checkbox"/> Maintain	
			<u> </u> % combined storm and sanitary sewer	<input type="checkbox"/> Own	<input type="checkbox"/> Maintain	
			<input type="checkbox"/> Unknown	<input type="checkbox"/> Own	<input type="checkbox"/> Maintain	
	Total Population Served	187				
			Separate Sanitary Sewer System	Combined Storm and Sanitary Sewer		
	Total percentage of each type of sewer line (in miles)		<u>100</u> %	<u> </u> %		
Indian Country	1.8	Is the treatment works located in Indian Country?				
		<input type="checkbox"/> Yes		<input checked="" type="checkbox"/> No		
Indian Country	1.9	Does the facility discharge to a receiving water that flows through Indian Country?				
		<input type="checkbox"/> Yes		<input checked="" type="checkbox"/> No		
Design and Actual Flow Rates	1.10	Provide design <i>and</i> actual flow rates in the designated spaces.			Design Flow Rate	
					0.06 mgd	
		Annual Average Flow Rates (Actual)				
		Two Years Ago	Last Year	This Year		
		0.027 mgd	0.027 mgd	0.023 mgd		
		Maximum Daily Flow Rates (Actual)				
	Two Years Ago	Last Year	This Year			
	0.075 mgd	0.043 mgd	0.055 mgd			
Discharge Points by Type	1.11	Provide the total number of effluent discharge points to waters of the United States by type.				
		Total Number of Effluent Discharge Points by Type				
		Treated Effluent	Untreated Effluent	Combined Sewer Overflows	Bypasses	Constructed Emergency Overflows
	1					

EPA Identification Number

NPDES Permit Number

Facility Name

Form Approved 03/05/19

AL0082848

Gilbertown WRRF

OMB No. 2040-0004

Outfalls Other Than to Waters of the United States

1.12 Does the POTW discharge wastewater to basins, ponds, or other surface impoundments that do not have outlets for discharge to waters of the United States?
 Yes No → SKIP to Item 1.14.

1.13 Provide the location of each surface impoundment and associated discharge information in the table below.

Surface Impoundment Location and Discharge Data

Location	Average Daily Volume Discharged to Surface Impoundment	Continuous or Intermittent (check one)
	gpd	<input type="checkbox"/> Continuous <input type="checkbox"/> Intermittent
	gpd	<input type="checkbox"/> Continuous <input type="checkbox"/> Intermittent
	gpd	<input type="checkbox"/> Continuous <input type="checkbox"/> Intermittent

1.14 Is wastewater applied to land?
 Yes No → SKIP to Item 1.16.

1.15 Provide the land application site and discharge data requested below.

Land Application Site and Discharge Data

Location	Size	Average Daily Volume Applied	Continuous or Intermittent (check one)
	acres	gpd	<input type="checkbox"/> Continuous <input type="checkbox"/> Intermittent
	acres	gpd	<input type="checkbox"/> Continuous <input type="checkbox"/> Intermittent
	acres	gpd	<input type="checkbox"/> Continuous <input type="checkbox"/> Intermittent

1.16 Is effluent transported to another facility for treatment prior to discharge?
 Yes No → SKIP to Item 1.21.

1.17 Describe the means by which the effluent is transported (e.g., tank truck, pipe).

1.18 Is the effluent transported by a party other than the applicant?
 Yes No → SKIP to Item 1.20.

1.19 Provide information on the transporter below.

Transporter Data

Entity name	Mailing address (street or P.O. box)	
City or town	State	ZIP code
Contact name (first and last)	Title	
Phone number	Email address	

Outfalls and Other Discharge or Disposal Methods

EPA Identification Number		NPDES Permit Number AL0082848		Facility Name Gilbertown WRRF		Form Approved 03/05/19 OMB No. 2040-0004	
Outfalls and Other Discharge or Disposal Methods Continued	1.20	In the table below, indicate the name, address, contact information, NPDES number, and average daily flow rate of the receiving facility.					
	Receiving Facility Data						
	Facility name				Mailing address (street or P.O. box)		
	City or town				State		ZIP code
	Contact name (first and last)				Title		
	Phone number				Email address		
	NPDES number of receiving facility (if any) <input checked="" type="checkbox"/> None				Average daily flow rate mgd		
	1.21	Is the wastewater disposed of in a manner other than those already mentioned in Items 1.14 through 1.21 that do not have outlets to waters of the United States (e.g., underground percolation, underground injection)? <input type="checkbox"/> Yes <input checked="" type="checkbox"/> No → SKIP to Item 1.23.					
	1.22	Provide information in the table below on these other disposal methods.					
	Information on Other Disposal Methods						
	Disposal Method Description	Location of Disposal Site	Size of Disposal Site	Annual Average Daily Discharge Volume	Continuous or Intermittent (check one)		
			acres	gpd	<input type="checkbox"/> Continuous <input type="checkbox"/> Intermittent		
			acres	gpd	<input type="checkbox"/> Continuous <input type="checkbox"/> Intermittent		
			acres	gpd	<input type="checkbox"/> Continuous <input type="checkbox"/> Intermittent		
Variance Requests	1.23	Do you intend to request or renew one or more of the variances authorized at 40 CFR 122.21(n)? (Check all that apply. Consult with your NPDES permitting authority to determine what information needs to be submitted and when.) <input type="checkbox"/> Discharges into marine waters (CWA Section 301(h)) <input type="checkbox"/> Water quality related effluent limitation (CWA Section 302(b)(2)) <input checked="" type="checkbox"/> Not applicable					
Contractor Information	1.24	Are any operational or maintenance aspects (related to wastewater treatment and effluent quality) of the treatment works the responsibility of a contractor? <input type="checkbox"/> Yes <input checked="" type="checkbox"/> No → SKIP to Section 2.					
	1.25	Provide location and contact information for each contractor in addition to a description of the contractor's operational and maintenance responsibilities.					
	Contractor Information						
			Contractor 1	Contractor 2	Contractor 3		
		Contractor name (company name)					
		Mailing address (street or P.O. box)					
		City, state, and ZIP code					
		Contact name (first and last)					
		Phone number					
		Email address					
	Operational and maintenance responsibilities of contractor						

SECTION 2. ADDITIONAL INFORMATION (40 CFR 122.21(j)(1) and (2))

Design Flow	Outfalls to Waters of the United States					
	2.1	Does the treatment works have a design flow greater than or equal to 0.1 mgd? <input type="checkbox"/> Yes <input checked="" type="checkbox"/> No → SKIP to Section 3.				
Inflow and Infiltration	2.2	Provide the treatment works' current average daily volume of inflow and infiltration.	Average Daily Volume of Inflow and Infiltration			
		Indicate the steps the facility is taking to minimize inflow and infiltration.				
Topographic Map	2.3	Have you attached a topographic map to this application that contains all the required information? (See instructions for specific requirements.) <input type="checkbox"/> Yes <input type="checkbox"/> No				
Flow Diagram	2.4	Have you attached a process flow diagram or schematic to this application that contains all the required information? (See instructions for specific requirements.) <input type="checkbox"/> Yes <input type="checkbox"/> No				
Scheduled Improvements and Schedules of Implementation	2.5	Are improvements to the facility scheduled? <input type="checkbox"/> Yes <input type="checkbox"/> No → SKIP to Section 3.				
		Briefly list and describe the scheduled improvements.				
		1.				
		2.				
		3.				
		4.				
	2.6	Provide scheduled or actual dates of completion for improvements.				
		Scheduled or Actual Dates of Completion for Improvements				
		Scheduled Improvement (from above)	Affected Outfalls (list outfall number)	Begin Construction (MM/DD/YYYY)	End Construction (MM/DD/YYYY)	Begin Discharge (MM/DD/YYYY)
		1.				
	2.					
	3.					
	4.					
2.7	Have appropriate permits/clearances concerning other federal/state requirements been obtained? Briefly explain your response. <input type="checkbox"/> Yes <input type="checkbox"/> No <input type="checkbox"/> None required or applicable					
	Explanation:					

EPA Identification Number

NPDES Permit Number
AL0082848Facility Name
Gilbertown WRRFForm Approved 03/05/19
OMB No. 2040-0004**SECTION 3. INFORMATION ON EFFLUENT DISCHARGES (40 CFR 122.21(j)(3) to (5))**

Description of Outfalls	3.1	Provide the following information for each outfall. (Attach additional sheets if you have more than three outfalls.)		
		Outfall Number <u>0011</u>	Outfall Number _____	Outfall Number _____
	State	Alabama		
	County	Choctaw		
	City or town	Gilbertown		
	Distance from shore	5 ft.	ft.	ft.
	Depth below surface	0 ft.	ft.	ft.
	Average daily flow rate	0.06 mgd	mgd	mgd
	Latitude	31° 53' 30.5"	° ' "	° ' "
Longitude	-88° 18' 55"	° ' "	° ' "	
Seasonal or Periodic Discharge Data	3.2	Do any of the outfalls described under Item 3.1 have seasonal or periodic discharges? <input type="checkbox"/> Yes <input checked="" type="checkbox"/> No → SKIP to Item 3.4.		
	3.3	If so, provide the following information for each applicable outfall.		
		Outfall Number _____	Outfall Number _____	Outfall Number _____
	Number of times per year discharge occurs			
	Average duration of each discharge (specify units)			
Average flow of each discharge	mgd	mgd	mgd	
Months in which discharge occurs				
Diffuser Type	3.4	Are any of the outfalls listed under Item 3.1 equipped with a diffuser? <input type="checkbox"/> Yes <input checked="" type="checkbox"/> No → SKIP to Item 3.6.		
	3.5	Briefly describe the diffuser type at each applicable outfall.		
		Outfall Number _____	Outfall Number _____	Outfall Number _____
Waters of the U.S.	3.6	Does the treatment works discharge or plan to discharge wastewater to waters of the United States from one or more discharge points? <input checked="" type="checkbox"/> Yes <input type="checkbox"/> No → SKIP to Section 6.		

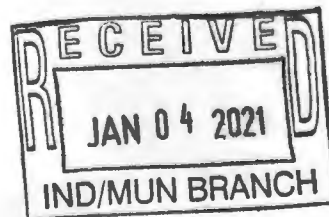

EPA Identification Number

NPDES Permit Number

Facility Name

Form Approved 03/05/19

AL0082848

Gilbertown WRRF

OMB No. 2040-0004

3.7		Provide the receiving water and related information (if known) for each outfall.		
Receiving Water Description		Outfall Number ⁰⁰¹¹ _____	Outfall Number _____	Outfall Number _____
	Receiving water name	Okatuppa Creek		
	Name of watershed, river, or stream system	Lower Tombigbee		
	U.S. Soil Conservation Service 14-digit watershed code			
	Name of state management/river basin			
	U.S. Geological Survey 8-digit hydrologic cataloging unit code			
	Critical low flow (acute)	cfs	cfs	cfs
	Critical low flow (chronic)	cfs	cfs	cfs
	Total hardness at critical low flow	mg/L of CaCO ₃	mg/L of CaCO ₃	mg/L of CaCO ₃
3.8		Provide the following information describing the treatment provided for discharges from each outfall.		
Treatment Description		Outfall Number ⁰⁰¹¹ _____	Outfall Number _____	Outfall Number _____
	Highest Level of Treatment (check all that apply per outfall)	<input checked="" type="checkbox"/> Primary <input checked="" type="checkbox"/> Equivalent to secondary <input checked="" type="checkbox"/> Secondary <input type="checkbox"/> Advanced <input type="checkbox"/> Other (specify) _____	<input type="checkbox"/> Primary <input type="checkbox"/> Equivalent to secondary <input type="checkbox"/> Secondary <input type="checkbox"/> Advanced <input type="checkbox"/> Other (specify) _____	<input type="checkbox"/> Primary <input type="checkbox"/> Equivalent to secondary <input type="checkbox"/> Secondary <input type="checkbox"/> Advanced <input type="checkbox"/> Other (specify) _____
	Design Removal Rates by Outfall			
	BOD ₅ or CBOD ₅	85 %	%	%
	TSS	85 %	%	%
	Phosphorus	<input checked="" type="checkbox"/> Not applicable %	<input type="checkbox"/> Not applicable %	<input type="checkbox"/> Not applicable %
	Nitrogen	<input checked="" type="checkbox"/> Not applicable %	<input type="checkbox"/> Not applicable %	<input type="checkbox"/> Not applicable %
Other (specify) _____	<input type="checkbox"/> Not applicable %	<input type="checkbox"/> Not applicable %	<input type="checkbox"/> Not applicable %	

EPA Identification Number		NPDES Permit Number AL0082848		Facility Name Gilbertown WRRF		Form Approved 03/05/19 OMB No. 2040-0004		
Treatment Description Continued	3.9	Describe the type of disinfection used for the effluent from each outfall in the table below. If disinfection varies by season, describe below.						
			Outfall Number <u>0011</u>	Outfall Number _____	Outfall Number _____			
	Disinfection type	UV						
	Seasons used	All						
	Dechlorination used?	<input checked="" type="checkbox"/> Not applicable <input type="checkbox"/> Yes <input type="checkbox"/> No	<input type="checkbox"/> Not applicable <input type="checkbox"/> Yes <input type="checkbox"/> No	<input type="checkbox"/> Not applicable <input type="checkbox"/> Yes <input type="checkbox"/> No	<input type="checkbox"/> Not applicable <input type="checkbox"/> Yes <input type="checkbox"/> No			
Effluent Testing Data	3.10	Have you completed monitoring for all Table A parameters and attached the results to the application package? <input checked="" type="checkbox"/> Yes <input type="checkbox"/> No						
	3.11	Have you conducted any WET tests during the 4.5 years prior to the date of the application on any of the facility's discharges or on any receiving water near the discharge points? <input type="checkbox"/> Yes <input checked="" type="checkbox"/> No → SKIP to Item 3.13.						
	3.12	Indicate the number of acute and chronic WET tests conducted since the last permit reissuance of the facility's discharges by outfall number or of the receiving water near the discharge points.						
			Outfall Number _____	Outfall Number _____	Outfall Number _____			
			Acute	Chronic	Acute	Chronic	Acute	Chronic
		Number of tests of discharge water						
		Number of tests of receiving water						
	3.13	Does the treatment works have a design flow greater than or equal to 0.1 mgd? <input type="checkbox"/> Yes <input checked="" type="checkbox"/> No → SKIP to Item 3.16.						
	3.14	Does the POTW use chlorine for disinfection, use chlorine elsewhere in the treatment process, or otherwise have reasonable potential to discharge chlorine in its effluent? <input type="checkbox"/> Yes → Complete Table B, including chlorine. <input type="checkbox"/> No → Complete Table B, omitting chlorine.						
	3.15	Have you completed monitoring for all applicable Table B pollutants and attached the results to this application package? <input type="checkbox"/> Yes <input type="checkbox"/> No						
3.16	Does one or more of the following conditions apply? <ul style="list-style-type: none"> The facility has a design flow greater than or equal to 1 mgd. The POTW has an approved pretreatment program or is required to develop such a program. The NPDES permitting authority has informed the POTW that it must sample for the parameters in Table C, must sample other additional parameters (Table D), or submit the results of WET tests for acute or chronic toxicity for each of its discharge outfalls (Table E). <input type="checkbox"/> Yes → Complete Tables C, D, and E as applicable. <input checked="" type="checkbox"/> No → SKIP to Section 4.							
3.17	Have you completed monitoring for all applicable Table C pollutants and attached the results to this application package? <input type="checkbox"/> Yes <input type="checkbox"/> No							
3.18	Have you completed monitoring for all applicable Table D pollutants required by your NPDES permitting authority and attached the results to this application package? <input type="checkbox"/> Yes <input type="checkbox"/> No additional sampling required by NPDES permitting authority.							

EPA Identification Number		NPDES Permit Number AL0082848		Facility Name Gilbertown WRRF		Form Approved 03/05/19 OMB No. 2040-0004	
Effluent Testing Data Continued	3.19	Has the POTW conducted either (1) minimum of four quarterly WET tests for one year preceding this permit application or (2) at least four annual WET tests in the past 4.5 years?					
	<input type="checkbox"/> Yes		<input type="checkbox"/> No → Complete tests and Table E and SKIP to Item 3.26.				
	3.20	Have you previously submitted the results of the above tests to your NPDES permitting authority?					
	<input type="checkbox"/> Yes		<input type="checkbox"/> No → Provide results in Table E and SKIP to Item 3.26.				
	3.21	Indicate the dates the data were submitted to your NPDES permitting authority and provide a summary of the results.					
	Date(s) Submitted (MM/DD/YYYY)			Summary of Results			
	3.22	Regardless of how you provided your WET testing data to the NPDES permitting authority, did any of the tests result in toxicity?					
<input type="checkbox"/> Yes		<input type="checkbox"/> No → SKIP to Item 3.26.					
3.23	Describe the cause(s) of the toxicity:						
3.24	Has the treatment works conducted a toxicity reduction evaluation?						
<input type="checkbox"/> Yes		<input type="checkbox"/> No → SKIP to Item 3.26.					
3.25	Provide details of any toxicity reduction evaluations conducted.						
3.26	Have you completed Table E for all applicable outfalls and attached the results to the application package?						
<input type="checkbox"/> Yes		<input type="checkbox"/> Not applicable because previously submitted information to the NPDES permitting authority.					
SECTION 4. INDUSTRIAL DISCHARGES AND HAZARDOUS WASTES (40 CFR 122.21(j)(6) and (7))							
Industrial Discharges and Hazardous Wastes	4.1	Does the POTW receive discharges from SIUs or NSCIUs?					
	<input type="checkbox"/> Yes		<input checked="" type="checkbox"/> No → SKIP to Item 4.7.				
	4.2	Indicate the number of SIUs and NSCIUs that discharge to the POTW.					
	Number of SIUs			Number of NSCIUs			
	4.3	Does the POTW have an approved pretreatment program?					
<input type="checkbox"/> Yes		<input type="checkbox"/> No					
4.4	Have you submitted either of the following to the NPDES permitting authority that contains information substantially identical to that required in Table F: (1) a pretreatment program annual report submitted within one year of the application or (2) a pretreatment program?						
<input type="checkbox"/> Yes		<input type="checkbox"/> No → SKIP to Item 4.6.					
4.5	Identify the title and date of the annual report or pretreatment program referenced in Item 4.4. SKIP to Item 4.7.						
4.6	Have you completed and attached Table F to this application package?						
<input type="checkbox"/> Yes		<input type="checkbox"/> No					

Industrial Discharges and Hazardous Wastes Continued

4.7 Does the POTW receive, or has it been notified that it will receive, by truck, rail, or dedicated pipe, any wastes that are regulated as RCRA hazardous wastes pursuant to 40 CFR 261?

Yes No → SKIP to Item 4.9.

4.8 If yes, provide the following information:

Hazardous Waste Number	Waste Transport Method (check all that apply)		Annual Amount of Waste Received	Units
	<input type="checkbox"/> Truck	<input type="checkbox"/> Rail		
	<input type="checkbox"/> Dedicated pipe	<input type="checkbox"/> Other (specify) _____		
	<input type="checkbox"/> Truck	<input type="checkbox"/> Rail		
	<input type="checkbox"/> Dedicated pipe	<input type="checkbox"/> Other (specify) _____		
	<input type="checkbox"/> Truck	<input type="checkbox"/> Rail		
	<input type="checkbox"/> Dedicated pipe	<input type="checkbox"/> Other (specify) _____		

4.9 Does the POTW receive, or has it been notified that it will receive, wastewaters that originate from remedial activities, including those undertaken pursuant to CERCLA and Sections 3004(7) or 3008(h) of RCRA?

Yes No → SKIP to Section 5.

4.10 Does the POTW receive (or expect to receive) less than 15 kilograms per month of non-acute hazardous wastes as specified in 40 CFR 261.30(d) and 261.33(e)?

Yes → SKIP to Section 5. No

4.11 Have you reported the following information in an attachment to this application: identification and description of the site(s) or facility(ies) at which the wastewater originates; the identities of the wastewater's hazardous constituents; and the extent of treatment, if any, the wastewater receives or will receive before entering the POTW?

Yes No

SECTION 5. COMBINED SEWER OVERFLOWS (40 CFR 122.21(j)(8))

CSO Map and Diagram

5.1 Does the treatment works have a combined sewer system?

Yes No → SKIP to Section 6.

5.2 Have you attached a CSO system map to this application? (See instructions for map requirements.)

Yes No

5.3 Have you attached a CSO system diagram to this application? (See instructions for diagram requirements.)

Yes No

EPA Identification Number	NPDES Permit Number AL0082848	Facility Name Gilbertown WRRF
---------------------------	----------------------------------	----------------------------------

Form Approved 03/05/19
OMB No. 2040-0004

CSO Outfall Description	5.4	For each CSO outfall, provide the following information. (Attach additional sheets as necessary.)		
		CSO Outfall Number ____	CSO Outfall Number ____	CSO Outfall Number ____
	City or town			
	State and ZIP code			
	County			
	Latitude	° ' "	° ' "	° ' "
	Longitude	° ' "	° ' "	° ' "
	Distance from shore	ft.	ft.	ft.
Depth below surface	ft.	ft.	ft.	
CSO Monitoring	5.5	Did the POTW monitor any of the following items in the past year for its CSO outfalls?		
		CSO Outfall Number ____	CSO Outfall Number ____	CSO Outfall Number ____
	Rainfall	<input type="checkbox"/> Yes <input type="checkbox"/> No	<input type="checkbox"/> Yes <input type="checkbox"/> No	<input type="checkbox"/> Yes <input type="checkbox"/> No
	CSO flow volume	<input type="checkbox"/> Yes <input type="checkbox"/> No	<input type="checkbox"/> Yes <input type="checkbox"/> No	<input type="checkbox"/> Yes <input type="checkbox"/> No
	CSO pollutant concentrations	<input type="checkbox"/> Yes <input type="checkbox"/> No	<input type="checkbox"/> Yes <input type="checkbox"/> No	<input type="checkbox"/> Yes <input type="checkbox"/> No
	Receiving water quality	<input type="checkbox"/> Yes <input type="checkbox"/> No	<input type="checkbox"/> Yes <input type="checkbox"/> No	<input type="checkbox"/> Yes <input type="checkbox"/> No
	CSO frequency	<input type="checkbox"/> Yes <input type="checkbox"/> No	<input type="checkbox"/> Yes <input type="checkbox"/> No	<input type="checkbox"/> Yes <input type="checkbox"/> No
Number of storm events	<input type="checkbox"/> Yes <input type="checkbox"/> No	<input type="checkbox"/> Yes <input type="checkbox"/> No	<input type="checkbox"/> Yes <input type="checkbox"/> No	
CSO Events in Past Year	5.6	Provide the following information for each of your CSO outfalls.		
		CSO Outfall Number ____	CSO Outfall Number ____	CSO Outfall Number ____
	Number of CSO events in the past year	events	events	events
	Average duration per event	hours <input type="checkbox"/> Actual or <input type="checkbox"/> Estimated	hours <input type="checkbox"/> Actual or <input type="checkbox"/> Estimated	hours <input type="checkbox"/> Actual or <input type="checkbox"/> Estimated
	Average volume per event	million gallons <input type="checkbox"/> Actual or <input type="checkbox"/> Estimated	million gallons <input type="checkbox"/> Actual or <input type="checkbox"/> Estimated	million gallons <input type="checkbox"/> Actual or <input type="checkbox"/> Estimated
Minimum rainfall causing a CSO event in last year	inches of rainfall <input type="checkbox"/> Actual or <input type="checkbox"/> Estimated	inches of rainfall <input type="checkbox"/> Actual or <input type="checkbox"/> Estimated	inches of rainfall <input type="checkbox"/> Actual or <input type="checkbox"/> Estimated	

AL0082848

CSO Receiving Waters

5.7	Provide the information in the table below for each of your CSO outfalls.			
	CSO Outfall Number _____	CSO Outfall Number _____	CSO Outfall Number _____	
	Receiving water name			
	Name of watershed/ stream system			
	U.S. Soil Conservation Service 14-digit watershed code (if known)	<input type="checkbox"/> Unknown	<input type="checkbox"/> Unknown	<input type="checkbox"/> Unknown
	Name of state management/river basin			
	U.S. Geological Survey 8-Digit Hydrologic Unit Code (if known)	<input type="checkbox"/> Unknown	<input type="checkbox"/> Unknown	<input type="checkbox"/> Unknown
	Description of known water quality impacts on receiving stream by CSO (see instructions for examples)			

SECTION 6. CHECKLIST AND CERTIFICATION STATEMENT (40 CFR 122.22(a) and (d))

Checklist and Certification Statement

6.1	In Column 1 below, mark the sections of Form 2A that you have completed and are submitting with your application. For each section, specify in Column 2 any attachments that you are enclosing to alert the permitting authority. Note that not all applicants are required to provide attachments.	
	Column 1	Column 2
	<input checked="" type="checkbox"/> Section 1: Basic Application Information for All Applicants	<input type="checkbox"/> w/ variance request(s) <input type="checkbox"/> w/ additional attachments
	<input checked="" type="checkbox"/> Section 2: Additional Information	<input checked="" type="checkbox"/> w/ topographic map <input checked="" type="checkbox"/> w/ additional attachments
	<input checked="" type="checkbox"/> Section 3: Information on Effluent Discharges	<input checked="" type="checkbox"/> w/ Table A <input type="checkbox"/> w/ Table D <input type="checkbox"/> w/ Table B <input type="checkbox"/> w/ Table E <input type="checkbox"/> w/ Table C <input type="checkbox"/> w/ additional attachments
	<input checked="" type="checkbox"/> Section 4: Industrial Discharges and Hazardous Wastes	<input type="checkbox"/> w/ SIU and NSCIU attachments <input type="checkbox"/> w/ Table F <input type="checkbox"/> w/ additional attachments
	<input checked="" type="checkbox"/> Section 5: Combined Sewer Overflows	<input type="checkbox"/> w/ CSO map <input type="checkbox"/> w/ additional attachments <input type="checkbox"/> w/ CSO system diagram
<input checked="" type="checkbox"/> Section 6: Checklist and Certification Statement	<input type="checkbox"/> w/ attachments	

6.2	Certification Statement	
	<i>I certify under penalty of law that this document and all attachments were prepared under my direction or supervision in accordance with a system designed to assure that qualified personnel properly gather and evaluate the information submitted. Based on my inquiry of the person or persons who manage the system, or those persons directly responsible for gathering the information, the information submitted is, to the best of my knowledge and belief, true, accurate, and complete. I am aware that there are significant penalties for submitting false information, including the possibility of fine and imprisonment for knowing violations.</i>	
	Name (print or type first and last name) Billy May	Official title Chairman
Signature <i>Billy C. May</i>	Date signed 5-1-20	

CSO Receiving Waters	5.7	Provide the information in the table below for each of your CSO outfalls.		
		CSO Outfall Number ____	CSO Outfall Number ____	CSO Outfall Number ____
	Receiving water name			
	Name of watershed/ stream system			
	U.S. Soil Conservation Service 14-digit watershed code (if known)	<input type="checkbox"/> Unknown	<input type="checkbox"/> Unknown	<input type="checkbox"/> Unknown
	Name of state management/river basin			
	U.S. Geological Survey 8-Digit Hydrologic Unit Code (if known)	<input type="checkbox"/> Unknown	<input type="checkbox"/> Unknown	<input type="checkbox"/> Unknown
	Description of known water quality impacts on receiving stream by CSO . (see instructions for examples)			

SECTION 6. CHECKLIST AND CERTIFICATION STATEMENT (40 CFR 122.22(a) and (d))

Checklist and Certification Statement	6.1	In Column 1 below, mark the sections of Form 2A that you have completed and are submitting with your application. For each section, specify in Column 2 any attachments that you are enclosing to alert the permitting authority. Note that not all applicants are required to provide attachments.	
		Column 1	Column 2
	<input checked="" type="checkbox"/>	Section 1: Basic Application Information for All Applicants	<input type="checkbox"/> w/ variance request(s) <input type="checkbox"/> w/ additional attachments
	<input checked="" type="checkbox"/>	Section 2: Additional Information	<input checked="" type="checkbox"/> w/ topographic map <input checked="" type="checkbox"/> w/ additional attachments
	<input checked="" type="checkbox"/>	Section 3: Information on Effluent Discharges	<input checked="" type="checkbox"/> w/ Table A <input type="checkbox"/> w/ Table D <input type="checkbox"/> w/ Table B <input type="checkbox"/> w/ Table E <input type="checkbox"/> w/ Table C <input type="checkbox"/> w/ additional attachments
	<input checked="" type="checkbox"/>	Section 4: Industrial Discharges and Hazardous Wastes	<input type="checkbox"/> w/ SIU and NSCIU attachments <input type="checkbox"/> w/ Table F <input type="checkbox"/> w/ additional attachments
	<input checked="" type="checkbox"/>	Section 5: Combined Sewer Overflows	<input type="checkbox"/> w/ CSO map <input type="checkbox"/> w/ additional attachments <input type="checkbox"/> w/ CSO system diagram
	<input checked="" type="checkbox"/>	Section 6: Checklist and Certification Statement	<input type="checkbox"/> w/ attachments
6.2	<p>Certification Statement</p> <p><i>I certify under penalty of law that this document and all attachments were prepared under my direction or supervision in accordance with a system designed to assure that qualified personnel properly gather and evaluate the information submitted. Based on my inquiry of the person or persons who manage the system, or those persons directly responsible for gathering the information, the information submitted is, to the best of my knowledge and belief, true, accurate, and complete. I am aware that there are significant penalties for submitting false information, including the possibility of fine and imprisonment for knowing violations.</i></p>		
	Name (print or type first and last name)	Official title	
	Billy May	Chairman	
	Signature	Date signed	

EPA Identification Number	NPDES Permit Number AL0082848	Facility Name Gilbertown WRRF	Outfall Number 0011
---------------------------	----------------------------------	----------------------------------	------------------------

Form Approved 03/05/19
OMB No. 2040-0004

TABLE A. EFFLUENT PARAMETERS FOR ALL POTWS

Pollutant	Maximum Daily Discharge		Average Daily Discharge			Analytical Method ¹	ML or MDL (include units)
	Value	Units	Value	Units	Number of Samples		
Biochemical oxygen demand <input type="checkbox"/> BOD ₅ or <input checked="" type="checkbox"/> CBOD ₅ (report one)	15.3	mg/l	6.7	mg/l	58	M512 B-201	2.0 mg/l <input type="checkbox"/> ML <input checked="" type="checkbox"/> MDL
Fecal coliform	4709	MPN/100 ml	217	MPN/100 ml	58	SM9223B	1 MPN <input type="checkbox"/> ML <input checked="" type="checkbox"/> MDL
Design flow rate	0.075	MGD	0.025	MGD	58		
pH (minimum)	7.2	std					
pH (maximum)	8.33	std					
Temperature (winter)							
Temperature (summer)							
Total suspended solids (TSS)	24	mg/l	6.5	mg/l	58	USGS 3765	1.0 mg/l <input type="checkbox"/> ML <input checked="" type="checkbox"/> MDL

¹ Sampling shall be conducted according to sufficiently sensitive test procedures (i.e., methods) approved under 40 CFR 136 for the analysis of pollutants or pollutant parameters or required under 40 CFR chapter 1, subchapter N or O. See instructions and 40 CFR 122.21(e)(3).

This page intentionally left blank.

EPA Identification Number	NPDES Permit Number ALD082848	Facility Name Gilbertown WRRF	Outfall Number
---------------------------	----------------------------------	----------------------------------	----------------

Form Approved 03/05/19
OMB No. 2040-0004

TABLE B. EFFLUENT PARAMETERS FOR ALL POTWS WITH A FLOW EQUAL TO OR GREATER THAN 0.1 MGD

Pollutant	Maximum Daily Discharge		Average Daily Discharge			Analytical Method ¹	ML or MDL (include units)
	Value	Units	Value	Units	Number of Samples		
Ammonia (as N)							<input type="checkbox"/> ML <input type="checkbox"/> MDL
Chlorine (total residual, TRC) ²							<input type="checkbox"/> ML <input type="checkbox"/> MDL
Dissolved oxygen							<input type="checkbox"/> ML <input type="checkbox"/> MDL
Nitrate/nitrite							<input type="checkbox"/> ML <input type="checkbox"/> MDL
Kjeldahl nitrogen							<input type="checkbox"/> ML <input type="checkbox"/> MDL
Oil and grease							<input type="checkbox"/> ML <input type="checkbox"/> MDL
Phosphorus							<input type="checkbox"/> ML <input type="checkbox"/> MDL
Total dissolved solids							<input type="checkbox"/> ML <input type="checkbox"/> MDL

¹ Sampling shall be conducted according to sufficiently sensitive test procedures (i.e., methods) approved under 40 CFR 136 for the analysis of pollutants or pollutant parameters or required under 40 CFR chapter I, subchapter N or O. See instructions and 40 CFR 122.21(e)(3).

² Facilities that do not use chlorine for disinfection, do not use chlorine elsewhere in the treatment process, and have no reasonable potential to discharge chlorine in their effluent are not required to report data for chlorine.

This page intentionally left blank.

EPA Identification Number	NPDES Permit Number AL0082848	Facility Name Gilbertown WRRF	Outfall Number
---------------------------	----------------------------------	----------------------------------	----------------

Form Approved 03/05/19
OMB No. 2040-0004

TABLE C. EFFLUENT PARAMETERS FOR SELECTED POTWS

Pollutant	Maximum Daily Discharge		Average Daily Discharge			Analytical Method ¹	ML or MDL (include units)
	Value	Units	Value	Units	Number of Samples		
Metals, Cyanide, and Total Phenols							
Hardness (as CaCO ₃)							<input type="checkbox"/> ML <input type="checkbox"/> MDL
Antimony, total recoverable							<input type="checkbox"/> ML <input type="checkbox"/> MDL
Arsenic, total recoverable							<input type="checkbox"/> ML <input type="checkbox"/> MDL
Beryllium, total recoverable							<input type="checkbox"/> ML <input type="checkbox"/> MDL
Cadmium, total recoverable							<input type="checkbox"/> ML <input type="checkbox"/> MDL
Chromium, total recoverable							<input type="checkbox"/> ML <input type="checkbox"/> MDL
Copper, total recoverable							<input type="checkbox"/> ML <input type="checkbox"/> MDL
Lead, total recoverable							<input type="checkbox"/> ML <input type="checkbox"/> MDL
Mercury, total recoverable							<input type="checkbox"/> ML <input type="checkbox"/> MDL
Nickel, total recoverable							<input type="checkbox"/> ML <input type="checkbox"/> MDL
Selenium, total recoverable							<input type="checkbox"/> ML <input type="checkbox"/> MDL
Silver, total recoverable							<input type="checkbox"/> ML <input type="checkbox"/> MDL
Thallium, total recoverable							<input type="checkbox"/> ML <input type="checkbox"/> MDL
Zinc, total recoverable							<input type="checkbox"/> ML <input type="checkbox"/> MDL
Cyanide							<input type="checkbox"/> ML <input type="checkbox"/> MDL
Total phenolic compounds							<input type="checkbox"/> ML <input type="checkbox"/> MDL
Volatile Organic Compounds							
Acrolein							<input type="checkbox"/> ML <input type="checkbox"/> MDL
Acrylonitrile							<input type="checkbox"/> ML <input type="checkbox"/> MDL
Benzene							<input type="checkbox"/> ML <input type="checkbox"/> MDL
Bromoform							<input type="checkbox"/> ML <input type="checkbox"/> MDL

EPA Identification Number	NPDES Permit Number AL0082848	Facility Name Gilbertown WRRF	Outfall Number
---------------------------	----------------------------------	----------------------------------	----------------

Form Approved 03/05/19
OMB No. 2040-0004

TABLE C. EFFLUENT PARAMETERS FOR SELECTED POTWS

Pollutant	Maximum Daily Discharge		Average Daily Discharge			Analytical Method ¹	ML or MDL (include units)
	Value	Units	Value	Units	Number of Samples		
Carbon tetrachloride							<input type="checkbox"/> ML <input type="checkbox"/> MDL
Chlorobenzene							<input type="checkbox"/> ML <input type="checkbox"/> MDL
Chlorodibromomethane							<input type="checkbox"/> ML <input type="checkbox"/> MDL
Chloroethane							<input type="checkbox"/> ML <input type="checkbox"/> MDL
2-chloroethylvinyl ether							<input type="checkbox"/> ML <input type="checkbox"/> MDL
Chloroform							<input type="checkbox"/> ML <input type="checkbox"/> MDL
Dichlorobromomethane							<input type="checkbox"/> ML <input type="checkbox"/> MDL
1,1-dichloroethane							<input type="checkbox"/> ML <input type="checkbox"/> MDL
1,2-dichloroethane							<input type="checkbox"/> ML <input type="checkbox"/> MDL
trans-1,2-dichloroethylene							<input type="checkbox"/> ML <input type="checkbox"/> MDL
1,1-dichloroethylene							<input type="checkbox"/> ML <input type="checkbox"/> MDL
1,2-dichloropropane							<input type="checkbox"/> ML <input type="checkbox"/> MDL
1,3-dichloropropylene							<input type="checkbox"/> ML <input type="checkbox"/> MDL
Ethylbenzene							<input type="checkbox"/> ML <input type="checkbox"/> MDL
Methyl bromide							<input type="checkbox"/> ML <input type="checkbox"/> MDL
Methyl chloride							<input type="checkbox"/> ML <input type="checkbox"/> MDL
Methylene chloride							<input type="checkbox"/> ML <input type="checkbox"/> MDL
1,1,2,2-tetrachloroethane							<input type="checkbox"/> ML <input type="checkbox"/> MDL
Tetrachloroethylene							<input type="checkbox"/> ML <input type="checkbox"/> MDL
Toluene							<input type="checkbox"/> ML <input type="checkbox"/> MDL
1,1,1-trichloroethane							<input type="checkbox"/> ML <input type="checkbox"/> MDL
1,1,2-trichloroethane							<input type="checkbox"/> ML <input type="checkbox"/> MDL

EPA Identification Number	NPDES Permit Number AL0082848	Facility Name Gilbertown WRRF	Outfall Number
---------------------------	----------------------------------	----------------------------------	----------------

Form Approved 03/05/19
OMB No. 2040-0004

TABLE C. EFFLUENT PARAMETERS FOR SELECTED POTWS

Pollutant	Maximum Daily Discharge		Average Daily Discharge			Analytical Method ¹	ML or MDL (include units)
	Value	Units	Value	Units	Number of Samples		
Trichloroethylene							<input type="checkbox"/> ML <input type="checkbox"/> MDL
Vinyl chloride							<input type="checkbox"/> ML <input type="checkbox"/> MDL
Acid-Extractable Compounds							
p-chloro-m-cresol							<input type="checkbox"/> ML <input type="checkbox"/> MDL
2-chlorophenol							<input type="checkbox"/> ML <input type="checkbox"/> MDL
2,4-dichlorophenol							<input type="checkbox"/> ML <input type="checkbox"/> MDL
2,4-dimethylphenol							<input type="checkbox"/> ML <input type="checkbox"/> MDL
4,6-dinitro-o-cresol							<input type="checkbox"/> ML <input type="checkbox"/> MDL
2,4-dinitrophenol							<input type="checkbox"/> ML <input type="checkbox"/> MDL
2-nitrophenol							<input type="checkbox"/> ML <input type="checkbox"/> MDL
4-nitrophenol							<input type="checkbox"/> ML <input type="checkbox"/> MDL
Pentachlorophenol							<input type="checkbox"/> ML <input type="checkbox"/> MDL
Phenol							<input type="checkbox"/> ML <input type="checkbox"/> MDL
2,4,6-trichlorophenol							<input type="checkbox"/> ML <input type="checkbox"/> MDL
Base-Neutral Compounds							
Acenaphthene							<input type="checkbox"/> ML <input type="checkbox"/> MDL
Acenaphthylene							<input type="checkbox"/> ML <input type="checkbox"/> MDL
Anthracene							<input type="checkbox"/> ML <input type="checkbox"/> MDL
Benzidine							<input type="checkbox"/> ML <input type="checkbox"/> MDL
Benzo(a)anthracene							<input type="checkbox"/> ML <input type="checkbox"/> MDL
Benzo(a)pyrene							<input type="checkbox"/> ML <input type="checkbox"/> MDL
3,4-benzofluoranthene							<input type="checkbox"/> ML <input type="checkbox"/> MDL

EPA Identification Number	NPDES Permit Number AL0082848	Facility Name Gilbertown WRRF	Outfall Number
---------------------------	----------------------------------	----------------------------------	----------------

Form Approved 03/05/19
OMB No. 2040-0004

TABLE C. EFFLUENT PARAMETERS FOR SELECTED POTWS

Pollutant	Maximum Daily Discharge		Average Daily Discharge			Analytical Method ¹	ML or MDL (include units)
	Value	Units	Value	Units	Number of Samples		
Benzo(ghi)perylene							<input type="checkbox"/> ML <input type="checkbox"/> MDL
Benzo(k)fluoranthene							<input type="checkbox"/> ML <input type="checkbox"/> MDL
Bis (2-chloroethoxy) methane							<input type="checkbox"/> ML <input type="checkbox"/> MDL
Bis (2-chloroethyl) ether							<input type="checkbox"/> ML <input type="checkbox"/> MDL
Bis (2-chloroisopropyl) ether							<input type="checkbox"/> ML <input type="checkbox"/> MDL
Bis (2-ethylhexyl) phthalate							<input type="checkbox"/> ML <input type="checkbox"/> MDL
4-bromophenyl phenyl ether							<input type="checkbox"/> ML <input type="checkbox"/> MDL
Butyl benzyl phthalate							<input type="checkbox"/> ML <input type="checkbox"/> MDL
2-chloronaphthalene							<input type="checkbox"/> ML <input type="checkbox"/> MDL
4-chlorophenyl phenyl ether							<input type="checkbox"/> ML <input type="checkbox"/> MDL
Chrysene							<input type="checkbox"/> ML <input type="checkbox"/> MDL
di-n-butyl phthalate							<input type="checkbox"/> ML <input type="checkbox"/> MDL
di-n-octyl phthalate							<input type="checkbox"/> ML <input type="checkbox"/> MDL
Dibenzo(a,h)anthracene							<input type="checkbox"/> ML <input type="checkbox"/> MDL
1,2-dichlorobenzene							<input type="checkbox"/> ML <input type="checkbox"/> MDL
1,3-dichlorobenzene							<input type="checkbox"/> ML <input type="checkbox"/> MDL
1,4-dichlorobenzene							<input type="checkbox"/> ML <input type="checkbox"/> MDL
3,3-dichlorobenzidine							<input type="checkbox"/> ML <input type="checkbox"/> MDL
Diethyl phthalate							<input type="checkbox"/> ML <input type="checkbox"/> MDL
Dimethyl phthalate							<input type="checkbox"/> ML <input type="checkbox"/> MDL
2,4-dinitrotoluene							<input type="checkbox"/> ML <input type="checkbox"/> MDL
2,6-dinitrotoluene							<input type="checkbox"/> ML <input type="checkbox"/> MDL

EPA Identification Number	NPDES Permit Number AL0082848	Facility Name Gilbertown WRRF	Outfall Number
---------------------------	----------------------------------	----------------------------------	----------------

Form Approved 03/05/19
OMB No. 2040-0004

TABLE C. EFFLUENT PARAMETERS FOR SELECTED POTWS

Pollutant	Maximum Daily Discharge		Average Daily Discharge			Analytical Method ¹	ML or MDL (include units)
	Value	Units	Value	Units	Number of Samples		
1,2-diphenylhydrazine							<input type="checkbox"/> ML <input type="checkbox"/> MDL
Fluoranthene							<input type="checkbox"/> ML <input type="checkbox"/> MDL
Fluorene							<input type="checkbox"/> ML <input type="checkbox"/> MDL
Hexachlorobenzene							<input type="checkbox"/> ML <input type="checkbox"/> MDL
Hexachlorobutadiene							<input type="checkbox"/> ML <input type="checkbox"/> MDL
Hexachlorocyclo-pentadiene							<input type="checkbox"/> ML <input type="checkbox"/> MDL
Hexachloroethane							<input type="checkbox"/> ML <input type="checkbox"/> MDL
Indeno(1,2,3-cd)pyrene							<input type="checkbox"/> ML <input type="checkbox"/> MDL
Isophorone							<input type="checkbox"/> ML <input type="checkbox"/> MDL
Naphthalene							<input type="checkbox"/> ML <input type="checkbox"/> MDL
Nitrobenzene							<input type="checkbox"/> ML <input type="checkbox"/> MDL
N-nitrosodi-n-propylamine							<input type="checkbox"/> ML <input type="checkbox"/> MDL
N-nitrosodimethylamine							<input type="checkbox"/> ML <input type="checkbox"/> MDL
N-nitrosodiphenylamine							<input type="checkbox"/> ML <input type="checkbox"/> MDL
Phenanthrene							<input type="checkbox"/> ML <input type="checkbox"/> MDL
Pyrene							<input type="checkbox"/> ML <input type="checkbox"/> MDL
1,2,4-trichlorobenzene							<input type="checkbox"/> ML <input type="checkbox"/> MDL

¹ Sampling shall be conducted according to sufficiently sensitive test procedures (i.e., methods) approved under 40 CFR 136 for the analysis of pollutants or pollutant parameters or required under 40 CFR Chapter I, Subchapter N or O. See instructions and 40 CFR 122.21(e)(3).

This page intentionally left blank.

EPA Identification Number	NPDES Permit Number AL0082848	Facility Name Gilbertown WRRF	Outfall Number
---------------------------	----------------------------------	----------------------------------	----------------

TABLE D. ADDITIONAL POLLUTANTS AS REQUIRED BY NPDES PERMITTING AUTHORITY

Pollutant (list)	Maximum Daily Discharge		Average Daily Discharge		Number of Samples	Analytical Method ¹	ML or MDL (include units)
	Value	Units	Value	Units			
<input type="checkbox"/> No additional sampling is required by NPDES permitting authority.							
							<input type="checkbox"/> ML <input type="checkbox"/> MDL
							<input type="checkbox"/> ML <input type="checkbox"/> MDL
							<input type="checkbox"/> ML <input type="checkbox"/> MDL
							<input type="checkbox"/> ML <input type="checkbox"/> MDL
							<input type="checkbox"/> ML <input type="checkbox"/> MDL
							<input type="checkbox"/> ML <input type="checkbox"/> MDL
							<input type="checkbox"/> ML <input type="checkbox"/> MDL
							<input type="checkbox"/> ML <input type="checkbox"/> MDL
							<input type="checkbox"/> ML <input type="checkbox"/> MDL
							<input type="checkbox"/> ML <input type="checkbox"/> MDL
							<input type="checkbox"/> ML <input type="checkbox"/> MDL
							<input type="checkbox"/> ML <input type="checkbox"/> MDL
							<input type="checkbox"/> ML <input type="checkbox"/> MDL
							<input type="checkbox"/> ML <input type="checkbox"/> MDL
							<input type="checkbox"/> ML <input type="checkbox"/> MDL
							<input type="checkbox"/> ML <input type="checkbox"/> MDL
							<input type="checkbox"/> ML <input type="checkbox"/> MDL
							<input type="checkbox"/> ML <input type="checkbox"/> MDL

¹ Sampling shall be conducted according to sufficiently sensitive test procedures (i.e., methods) approved under 40 CFR 136 for the analysis of pollutants or pollutant parameters or required under 40 CFR chapter I, subchapter N or O. See instructions and 40 CFR 122.21(e)(3).

This page intentionally left blank.

EPA Identification Number	NPDES Permit Number AL0082848	Facility Name Gilbertown WRRF	Outfall Number
---------------------------	----------------------------------	----------------------------------	----------------

Form Approved 03/05/19
OMB No. 2040-0004

TABLE E. EFFLUENT MONITORING FOR WHOLE EFFLUENT TOXICITY			
The table provides response space for one whole effluent toxicity sample. Copy the table to report additional test results.			
Test Information			
	Test Number _____	Test Number _____	Test Number _____
Test species			
Age at initiation of test			
Outfall number			
Date sample collected			
Date test started			
Duration			
Toxicity Test Methods			
Test method number			
Manual title			
Edition number and year of publication			
Page number(s)			
Sample Type			
Check one:	<input type="checkbox"/> Grab <input type="checkbox"/> 24-hour composite	<input type="checkbox"/> Grab <input type="checkbox"/> 24-hour composite	<input type="checkbox"/> Grab <input type="checkbox"/> 24-hour composite
Sample Location			
Check one:	<input type="checkbox"/> Before Disinfection <input type="checkbox"/> After Disinfection <input type="checkbox"/> After Dechlorination	<input type="checkbox"/> Before Disinfection <input type="checkbox"/> After Disinfection <input type="checkbox"/> After Dechlorination	<input type="checkbox"/> Before disinfection <input type="checkbox"/> After disinfection <input type="checkbox"/> After dechlorination
Point in Treatment Process			
Describe the point in the treatment process at which the sample was collected for each test.			
Toxicity Type			
Indicate for each test whether the test was performed to assess acute or chronic toxicity, or both. (Check one response.)	<input type="checkbox"/> Acute <input type="checkbox"/> Chronic <input type="checkbox"/> Both	<input type="checkbox"/> Acute <input type="checkbox"/> Chronic <input type="checkbox"/> Both	<input type="checkbox"/> Acute <input type="checkbox"/> Chronic <input type="checkbox"/> Both

EPA Identification Number	NPDES Permit Number AL0082848	Facility Name Gilbertown WRRF	Outfall Number
---------------------------	----------------------------------	----------------------------------	----------------

Form Approved 03/05/19
OMB No. 2040-0004

TABLE E. EFFLUENT MONITORING FOR WHOLE EFFLUENT TOXICITY						
The table provides response space for one whole effluent toxicity sample. Copy the table to report additional test results.						
Test Type	Test Number	Test Number	Test Number	Test Number	Test Number	Test Number
Indicate the type of test performed. (Check one response.)	<input type="checkbox"/> Static <input type="checkbox"/> Static-renewal <input type="checkbox"/> Flow-through	<input type="checkbox"/> Static <input type="checkbox"/> Static-renewal <input type="checkbox"/> Flow-through	<input type="checkbox"/> Static <input type="checkbox"/> Static-renewal <input type="checkbox"/> Flow-through	<input type="checkbox"/> Static <input type="checkbox"/> Static-renewal <input type="checkbox"/> Flow-through	<input type="checkbox"/> Static <input type="checkbox"/> Static-renewal <input type="checkbox"/> Flow-through	<input type="checkbox"/> Static <input type="checkbox"/> Static-renewal <input type="checkbox"/> Flow-through
Source of Dilution Water	Indicate the source of dilution water. (Check one response.)					
	<input type="checkbox"/> Laboratory water <input type="checkbox"/> Receiving water	<input type="checkbox"/> Laboratory water <input type="checkbox"/> Receiving water	<input type="checkbox"/> Laboratory water <input type="checkbox"/> Receiving water	<input type="checkbox"/> Laboratory water <input type="checkbox"/> Receiving water	<input type="checkbox"/> Laboratory water <input type="checkbox"/> Receiving water	<input type="checkbox"/> Laboratory water <input type="checkbox"/> Receiving water
	If laboratory water, specify type.					
	If receiving water, specify source.					
Type of Dilution Water	Indicate the type of dilution water. If salt water, specify "natural" or type of artificial sea salts or brine used.					
	<input type="checkbox"/> Fresh water <input type="checkbox"/> Salt water (specify)	<input type="checkbox"/> Fresh water <input type="checkbox"/> Salt water (specify)	<input type="checkbox"/> Fresh water <input type="checkbox"/> Salt water (specify)	<input type="checkbox"/> Fresh water <input type="checkbox"/> Salt water (specify)	<input type="checkbox"/> Fresh water <input type="checkbox"/> Salt water (specify)	<input type="checkbox"/> Fresh water <input type="checkbox"/> Salt water (specify)
Percentage Effluent Used	Specify the percentage effluent used for all concentrations in the test series.					
Parameters Tested	Check the parameters tested.					
	<input type="checkbox"/> pH <input type="checkbox"/> Salinity <input type="checkbox"/> Temperature	<input type="checkbox"/> Ammonia <input type="checkbox"/> Dissolved oxygen	<input type="checkbox"/> pH <input type="checkbox"/> Salinity <input type="checkbox"/> Temperature	<input type="checkbox"/> Ammonia <input type="checkbox"/> Dissolved oxygen	<input type="checkbox"/> pH <input type="checkbox"/> Salinity <input type="checkbox"/> Temperature	<input type="checkbox"/> Ammonia <input type="checkbox"/> Dissolved oxygen
Acute Test Results						
Percent survival in 100% effluent		%		%		%
LC ₅₀						
95% confidence interval		%		%		%
Control percent survival		%		%		%

EPA Identification Number	NPDES Permit Number AL0082848	Facility Name Gilbertown WRRF	Outfall Number
---------------------------	----------------------------------	----------------------------------	----------------

Form Approved 03/05/19
OMB No. 2040-0004

TABLE E. EFFLUENT MONITORING FOR WHOLE EFFLUENT TOXICITY						
The table provides response space for one whole effluent toxicity sample. Copy the table to report additional test results.						
	Test Number _____	Test Number _____	Test Number _____	Test Number _____	Test Number _____	Test Number _____
Acute Test Results Continued						
Other (describe)						
Chronic Test Results						
NOEC	%	%	%	%	%	%
IC ₂₅	%	%	%	%	%	%
Control percent survival	%	%	%	%	%	%
Other (describe)						
Quality Control/Quality Assurance						
Is reference toxicant data available?	<input type="checkbox"/> Yes	<input type="checkbox"/> No	<input type="checkbox"/> Yes	<input type="checkbox"/> No	<input type="checkbox"/> Yes	<input type="checkbox"/> No
Was reference toxicant test within acceptable bounds?	<input type="checkbox"/> Yes	<input type="checkbox"/> No	<input type="checkbox"/> Yes	<input type="checkbox"/> No	<input type="checkbox"/> Yes	<input type="checkbox"/> No
What date was reference toxicant test run (MM/DD/YYYY)?						
Other (describe)						

This page intentionally left blank.

EPA Identification Number	NPDES Permit Number AL0082848	Facility Name Gilbertown WRRF
---------------------------	----------------------------------	----------------------------------

Form Approved 03/05/19
OMB No. 2040-0004

TABLE F. INDUSTRIAL DISCHARGE INFORMATION			
Response space is provided for three SIUs. Copy the table to report information for additional SIUs.			
	SIU _____	SIU _____	SIU _____
Name of SIU			
Mailing address (street or P.O. box)			
City, state, and ZIP code			
Description of all industrial processes that affect or contribute to the discharge.			
List the principal products and raw materials that affect or contribute to the SIU's discharge.			
Indicate the average daily volume of wastewater discharged by the SIU.	gpd	gpd	gpd
How much of the average daily volume is attributable to process flow?	gpd	gpd	gpd
How much of the average daily volume is attributable to non-process flow?	gpd	gpd	gpd
Is the SIU subject to local limits?	<input type="checkbox"/> Yes <input type="checkbox"/> No	<input type="checkbox"/> Yes <input type="checkbox"/> No	<input type="checkbox"/> Yes <input type="checkbox"/> No
Is the SIU subject to categorical standards?	<input type="checkbox"/> Yes <input type="checkbox"/> No	<input type="checkbox"/> Yes <input type="checkbox"/> No	<input type="checkbox"/> Yes <input type="checkbox"/> No

EPA Identification Number

NPDES Permit Number
AL0082848Facility Name
Gilbertown WRRFForm Approved 03/05/19
OMB No. 2040-0004**TABLE F. INDUSTRIAL DISCHARGE INFORMATION**

Response space is provided for three SIUs. Copy the table to report information for additional SIUs.

	SIU _____	SIU _____	SIU _____
Under what categories and subcategories is the SIU subject?			
Has the POTW experienced problems (e.g., upsets, pass-through interferences) in the past 4.5 years that are attributable to the SIU?	<input type="checkbox"/> Yes <input type="checkbox"/> No	<input type="checkbox"/> Yes <input type="checkbox"/> No	<input type="checkbox"/> Yes <input type="checkbox"/> No
If yes, describe.			

GILBERTTOWN WATER RESOURCE RECOVERY FACILITY

RECEIVED
MAY 05 2020
IND/MUN BRANCH

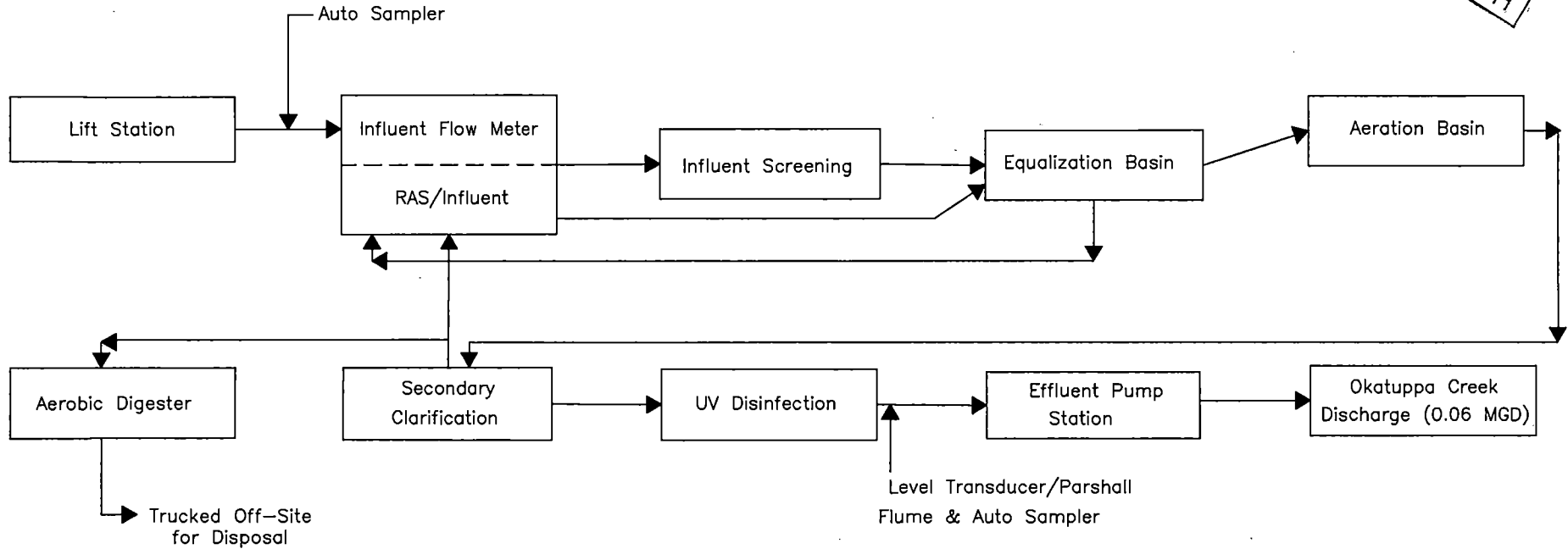

UTILITIES BOARD OF THE TOWN OF GILBERTTOWN
NPDES PERMIT RENEWAL
GILBERTTOWN WRRF
HIGHWAY 17
CHOCTAW COUNTY, ALABAMA



FIGURE 3
PROCESS FLOW DIAGRAM

PROJECT NO: 19-1101-0205

DATE: JANUARY 2020

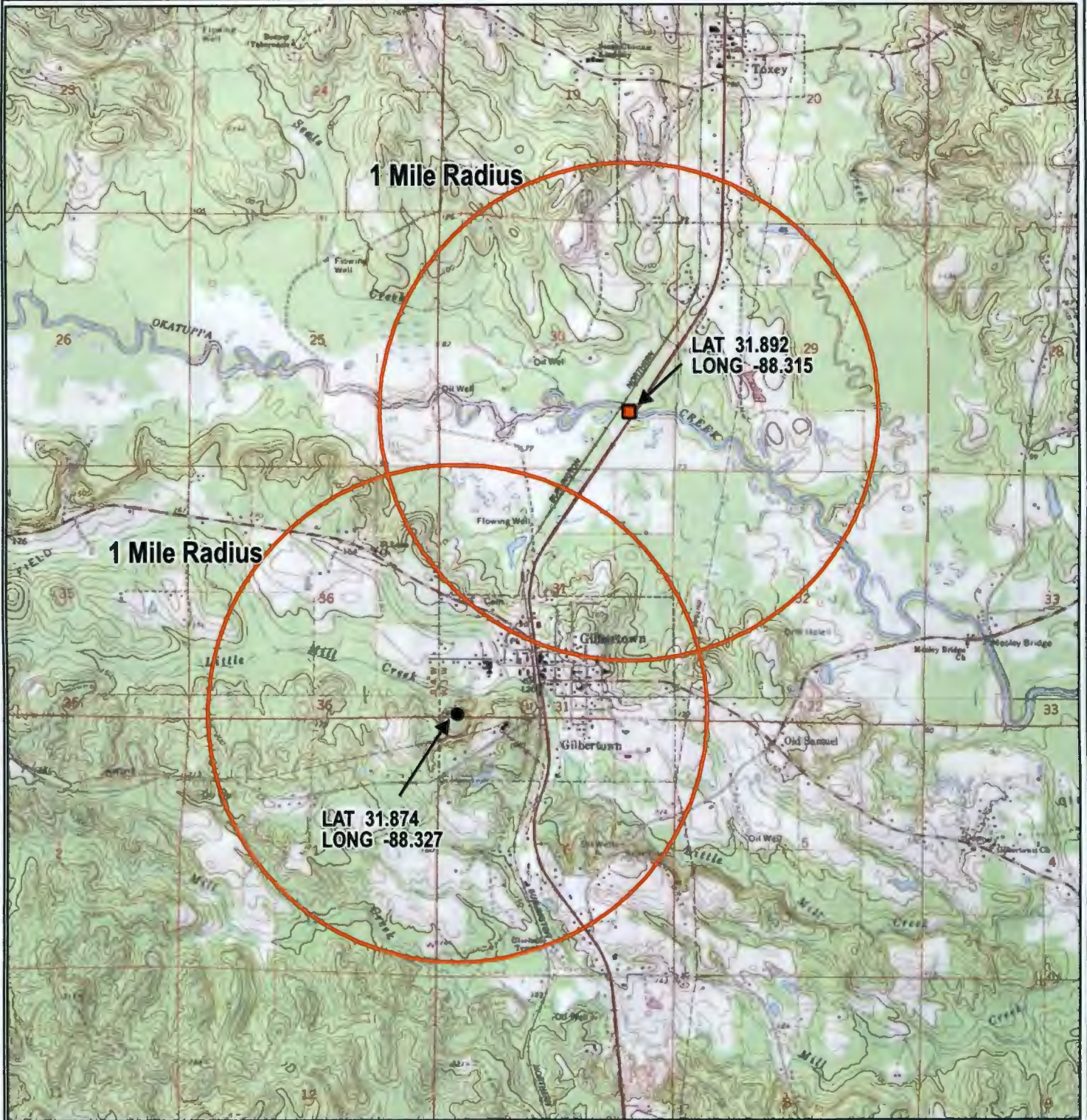

LEGEND

- Project Site
- Outfall
- 1 Mile Buffer

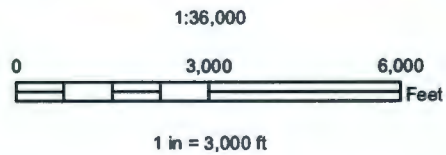

Copyright:© 2013 National Geographic Society, i-cubed

UTILITIES BOARD OF THE TOWN OF GILBERTOWN
 NPDES PERMIT RENEWAL
 GILBERTOWN WRRF
 HIGHWAY 17
 CHOCTAW COUNTY, ALABAMA



**FIGURE 1
 TOPOGRAPHIC MAP**

PROJECT NO.:
 19-1101-0205

DATE:
 JANUARY 2020



LEGEND

 Project Site

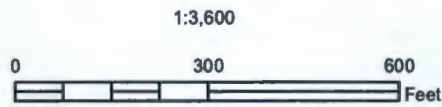

Source: Esri, DigitalGlobe, GeoEye, Earthstar Geographics, CNES/Airbus DS, USDA, USGS, AeroGRID, IGN, and the GIS User Community
NAIP 2006 IMAGERY - 1 Meter Resolution

UTILITIES BOARD OF THE TOWN OF GILBERTOWN
NPDES PERMIT RENEWAL
GILBERTOWN WRRF
HIGHWAY 17
CHOCTAW COUNTY, ALABAMA



FIGURE 2
AERIAL PHOTOGRAPH

PROJECT NO.:
19-1101-0205

DATE:
JANUARY 2020

ALABAMA DEPARTMENT OF ENVIRONMENTAL MANAGEMENT (ADEM)

NPDES INDIVIDUAL PERMIT APPLICATION

SUPPLEMENTARY INFORMATION FOR PUBLICLY-OWNED TREATMENT WORKS (POTW), OTHER TREATMENT WORKS TREATING DOMESTIC SEWAGE (TWTDS), AND PUBLIC WATER SUPPLY TREATMENT PLANTS

Instructions: This form should be used to submit the required supplementary information for an application for an NPDES individual permit for Publicly Owned Treatment Works (POTW) and other Treatment Works Treating Domestic Sewage (TWTDS). The completed application should be submitted to ADEM in duplicate. If insufficient space is available to address any item, please continue on an attached sheet of paper. Please mark "N/A" in the appropriate box when an item is not applicable to the applicant. Please type or print legibly in blue or black ink. Mail the completed application to:

ADEM-Water Division
Municipal Section
P O Box 301463
Montgomery, AL 36130-1463

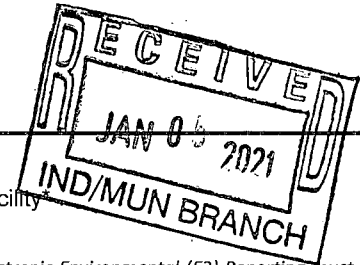

PURPOSE OF THIS APPLICATION

- Initial Permit Application for New Facility*
Modification of Existing Permit
Revocation & Reissuance of Existing Permit

- Initial Permit Application for Existing Facility
Reissuance of Existing Permit

* An application for participation in the ADEM's Electronic Environmental (E2) Reporting must be submitted to allow permittee to electronically submit reports as required.

SECTION A - GENERAL INFORMATION

1. Facility Name: Gilbertown Water Resources Recovery Facility

a. Operator Name: Utilities Board of the Town of Gilbertown

b. Is the operator identified in A.1.a, the owner of the facility? [X] Yes [] No
If no, provide name and address of the operator and submit information indicating the operator's scope of responsibility for the facility.

c. Name of Permittee* if different than Operator:
*Permittee will be responsible for compliance with the conditions of the permit

2. NPDES Permit Number: AL 0082848 (Not applicable if initial permit application)

3. Facility Physical Location: (Attach a map with location marked; street, route no. or other specific identifier)
Street: 13217 Choctaw Avenue
City: Gilbertown County: Choctaw State: AL Zip: 36908
Facility Location (Front Gate): Latitude: 31.874 Longitude: -88.327

4. Facility Mailing Address: 13217 Choctaw Avenue
City: Gilbertown County: Choctaw State: AL Zip: 36908

5. Responsible Official (as described on last page of this application):
Name and Title: Billy May, Chairman
Address: 13217 Choctaw Avenue
City: Gilbertown State: AL Zip: 36908
Phone Number: (251) 843-2766 Email Address: sdowney@gilbertown utilities.com

6. Designated Facility/DMR Contact:

Name and Title: Billy May, Chairman

Phone Number: (251) 843-2766

Email Address: sdowney@gilbertownutilities.com

7. Designated Emergency Contact:

Name and Title: Billy May, Chairman

Phone Number: (251) 843-2766

Email Address: sdowney@gilbertownutilities.com

8. Please complete this section if the Applicant's business entity is a Proprietorship or Limited Liability Company (LLC) with a responsible official not listed in A.5.

Name and Title: _____

Address: _____

City: _____ State: _____ Zip: _____

Phone Number: _____ Email Address: _____

9. Permit numbers for Applicant's previously issued NPDES Permits and identification of any other State Environmental Permits presently held by the Applicant within the State of Alabama:

<u>Permit Type</u>	<u>Permit Number</u>	<u>Held By</u>
NPDES	AL 0082848	Utilities Board of the Town of Gilbertown
_____	_____	_____
_____	_____	_____
_____	_____	_____
_____	_____	_____

10. Identify all Administrative Complaints, Notices of Violation, Directives, or Administrative Orders, Consent Decrees, or Litigation concerning water pollution or other permit violations, if any against the Applicant within the State of Alabama in the past five years (attach additional sheets if necessary):

<u>Facility Name</u>	<u>Permit Number</u>	<u>Type of Action</u>	<u>Date of Action</u>
N/A	_____	_____	_____
_____	_____	_____	_____
_____	_____	_____	_____
_____	_____	_____	_____
_____	_____	_____	_____

SECTION B – WASTEWATER DISCHARGE INFORMATION

1. List the following historical monthly flow rates recorded for the past five years for each outfall:

Outfall No.	Highest Flow in Last 12 Months (MGD)	Highest Daily Flow (MGD)	Average Flow (MGD)
0011	0.055	0.075	0.025

2. Attach a process flow schematic of the treatment process, including the size of each unit operation and sample collection locations.

3. Do you share an outfall with another facility? Yes No (If no, continue to B.4)

For each shared outfall, provide the following:

Applicant's Outfall No.	Name of Other Permittee/Facility	NPDES Permit No.	Where is sample collected by Applicant?

4. Do you have, or plan to have, automatic sampling equipment or continuous wastewater flow metering equipment at this facility?

Current:	Flow Metering	<input checked="" type="checkbox"/> Yes	<input type="checkbox"/> No	<input type="checkbox"/> N/A
	Sampling Equipment	<input checked="" type="checkbox"/> Yes	<input type="checkbox"/> No	<input type="checkbox"/> N/A
Planned:	Flow Metering	<input type="checkbox"/> Yes	<input type="checkbox"/> No	<input type="checkbox"/> N/A
	Sampling Equipment	<input type="checkbox"/> Yes	<input type="checkbox"/> No	<input type="checkbox"/> N/A

If so, please attach a schematic diagram of the sewer system indicating the present or future location of this equipment and describe the equipment below:

Flow from the Facility is determined using an ultrasonic flow meter with a 60 degree v-notch weir. Sampling is accomplished using two Isco automatic samplers. The Influent sampler is at the head of the plant and the Effluent sampler in the effluent box.

5. Are any wastewater collection or treatment modifications or expansions planned during the next three years that could alter wastewater volumes or characteristics (Note: Permit Modification may be required)? Yes No

Briefly describe these changes and any potential or anticipated effects on the wastewater quality and quantity: (Attach additional sheets if needed.)

SECTION C – WASTE STORAGE AND DISPOSAL INFORMATION

Describe the location of all sites used for the storage of solids or liquids that have any potential for accidental discharge to a water of the state, either directly or indirectly via storm sewer, municipal sewer, municipal wastewater treatment plants, or other collection or distribution systems that are located at or operated by the subject existing or proposed NPDES- permitted facility. Indicate the location of any potential release areas and provide a map or detailed narrative description of the areas of concern as an attachment to this application:

Description of Waste	Description of Storage Location
Waste Sludge	Solids Separation Tank (Digester)

Describe the location of any sites used for the ultimate disposal of solid or liquid waste materials or residuals (e.g. sludges) generated by any wastewater treatment system located at the facility.

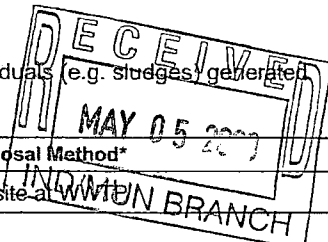

Description of Waste	Quantity (lbs/day)	Disposal Method*
Waste Sludge	17	Off-site at INDIAN WWTTP BRANCH

*Indicate any wastes disposed at an off-site treatment facility and any wastes that are disposed on-site

SECTION D – INDUSTRIAL INDIRECT DISCHARGE CONTRIBUTORS

a. List the existing and proposed industrial source wastewater contributions to the municipal wastewater treatment system (Attach other sheets if necessary)

Company Name	Description of Industrial Wastewater	Existing or Proposed	Flow (MGD)	Subject to SID Permit?	
N/A	None	None	None	<input type="checkbox"/> Yes	<input checked="" type="checkbox"/> No
				<input type="checkbox"/> Yes	<input type="checkbox"/> No
				<input type="checkbox"/> Yes	<input type="checkbox"/> No
				<input type="checkbox"/> Yes	<input type="checkbox"/> No

b. Are industrial wastewater contributions regulated via a locally approved sewer use ordinance? Yes No
If yes, please attach a copy of the ordinance.

SECTION E – COASTAL ZONE INFORMATION

Is the discharge(s) located within the 10-foot elevation contour and within the limits of Mobile or Baldwin County? Yes No
If yes, complete items E.1 – E.12 below:

- | | Yes | No |
|--|--------------------------|--------------------------|
| 1. Does the project require new construction? | <input type="checkbox"/> | <input type="checkbox"/> |
| 2. Will the project be a source of new air emissions?..... | <input type="checkbox"/> | <input type="checkbox"/> |
| 3. Does the project involve dredging and/or filling of a wetland area or water way? | <input type="checkbox"/> | <input type="checkbox"/> |
| If Yes, has the Corps of Engineers (COE) permit been received? | <input type="checkbox"/> | <input type="checkbox"/> |
| COE Project No. _____ | | |
| 4. Does the project involve wetlands and/or submersed grassbeds?..... | <input type="checkbox"/> | <input type="checkbox"/> |
| 5. Are oyster reefs located near the project site? | <input type="checkbox"/> | <input type="checkbox"/> |
| If Yes, include a map showing project and discharge location with respect to oyster reefs | | |
| 6. Does the project involve the site development, construction and operation of an energy facility as defined in ADEM Admin. Code r. 335-8-1-.02(bb)? | <input type="checkbox"/> | <input type="checkbox"/> |
| 7. Does the project involve mitigation of shoreline or coastal area erosion?..... | <input type="checkbox"/> | <input type="checkbox"/> |
| 8. Does the project involve construction on beaches or dune areas? | <input type="checkbox"/> | <input type="checkbox"/> |
| 9. Will the project interfere with public access to coastal waters? | <input type="checkbox"/> | <input type="checkbox"/> |
| 10. Does the project lie within the 100-year floodplain? | <input type="checkbox"/> | <input type="checkbox"/> |
| 11. Does the project involve the registration, sale, use, or application of pesticides? | <input type="checkbox"/> | <input type="checkbox"/> |
| 12. Does the project propose or require construction of a new well or to alter an existing groundwater well to pump more than 50 gallons per day (GPD)?..... | <input type="checkbox"/> | <input type="checkbox"/> |
| If yes, has the applicable permit for groundwater recovery or for groundwater well installation been obtained? | <input type="checkbox"/> | <input type="checkbox"/> |

SECTION F – ANTI-DEGRADATION EVALUATION

In accordance with 40 CFR §131.12 and the ADEM Admin. Code r. 335-6-10-.04 for anti-degradation, the following information must be provided, if applicable. It is the applicant's responsibility to demonstrate the social and economic importance of the proposed activity. If further information is required to make this demonstration, attach additional sheets to the application.

1. Is this a new or increased discharge that began after April 3, 1991? Yes No
If yes, complete F.2 below. If no, go to Section G.

2. Has an Anti-Degradation Analysis been previously conducted and submitted to the Department for the new or increased discharge referenced in F.1? Yes No

If yes, do not complete this section.

If no and the discharge is to a Tier II waterbody as defined in ADEM Admin. Code r. 335-6-10-.12(4), complete F.2.A – F.2.F below, ADEM Form 311-Alternatives Analysis, and either ADEM Form 312 or ADEM Form 313- Calculation of Total Annualized Project Costs (Public-Sector or Private-Sector Projects, whichever is applicable). ADEM Form 312 or ADEM Form 313, whichever is applicable, must be provided for each treatment discharge alternative considered technically viable. ADEM forms can be found on the Department's website at <http://adem.alabama.gov/DeptForms/>.

Information required for new or increased discharges to high quality waters:

A. What environmental or public health problem will the discharger be correcting?

B. How much will the discharger be increasing employment (at its existing facility or as the result of locating a new facility)?

C. How much reduction in employment will the discharger be avoiding?

D. How much additional state or local taxes will the discharger be paying?

E. What public service to the community will the discharger be providing?

F. What economic or social benefit will the discharger be providing to the community?

SECTION G – EPA Application Forms

All Applicants must submit certain EPA permit application forms. More than one application form may be required from a POTW or other TWTDS depending on the number and types of discharges or outfalls. The EPA application forms are found on the Department's website at <http://adem.alabama.gov/programs/water/waterforms.cnt>. The EPA application forms must be submitted in duplicate as follows:

1. All applicants must submit Form 1.
2. Applicants for new or existing discharges of sanitary wastewater from Publicly-Owned Treatment Works (POTW) and Other Treatment Works Treating Domestic Sewage (TWTDS) must submit Form 2A.
3. Applicants for new or existing land application of sanitary wastewater must submit Form 2A and, if the land application site is not completely bermed to prevent runoff, applicants must also submit Form 2F.
4. Applicants for new and existing discharges of process wastewater from water treatment facilities (i.e. public water supply treatment plants) must submit Form 2C.
5. Applicants that generate sewage sludge, derive a material from sewage sludge, or dispose of sewage sludge must submit Part 2 of Form 2S.

SECTION H- ENGINEERING REPORT/BMP PLAN REQUIREMENTS

Any Engineering Report or Best Management Practice (BMP) Plans required to be submitted to ADEM by the applicant must be in accordance with ADEM 335-6-6-.08(i) & (j).

SECTION I- RECEIVING WATERS

Outfall No.	Receiving Water(s)	303(d) Segment?		Included in TMDL?*	
0011	Okatuppa Creek	<input type="checkbox"/> Yes	<input checked="" type="checkbox"/> No	<input type="checkbox"/> Yes	<input checked="" type="checkbox"/> No
		<input type="checkbox"/> Yes	<input type="checkbox"/> No	<input type="checkbox"/> Yes	<input type="checkbox"/> No
		<input type="checkbox"/> Yes	<input type="checkbox"/> No	<input type="checkbox"/> Yes	<input type="checkbox"/> No

*If a TMDL Compliance Schedule is requested, the following should be attached as supporting documentation:

- (1) Justification for the requested Compliance Schedule (e.g. time for design and installation of control equipment, etc.);
- (2) Monitoring results for the pollutant(s) of concern which have not previously been submitted to the Department (sample collection dates, analytical results (mass and concentration), methods utilized, MDL/ML, etc. should be submitted as available);
- (3) Requested interim limitations, if applicable;
- (4) Date of final compliance with the TMDL limitations; and,
- (5) Any other additional information available to support requested compliance schedule.

SECTION J - APPLICATION CERTIFICATION

The information contained in this form must be certified by a responsible official as defined in ADEM Administrative Code r. 335-6-6-.09 "signatories to permit applications and reports" (see below).

"I certify under penalty of law that this document and all attachments were prepared under my direction or supervision in accordance with a system designed to assure that qualified personnel properly gather and evaluate the information submitted. Based on my inquiry of the person or persons who manage the system, or those persons directly responsible for gathering the information, the information submitted is, to the best of my knowledge and belief, true, accurate, and complete. I am aware that there are significant penalties for submitting false information including the possibility of fine and imprisonment for knowing violations."

Signature of Responsible Official: Billy May Date Signed: 3-3-2020
 Name and Title: Billy May, Chairman

If the Responsible Official signing this application is not identified in Section A.5 or A.8, provide the following information:

Mailing Address: 13217 Choctaw Avenue
 City: Gilbertown State: AL Zip: 36908
 Phone Number: (251) 843-2766 Email Address: sdowney@gilbertownutilities.com

335-6-6-.09 SIGNATORIES TO PERMIT APPLICATIONS AND REPORTS.

- (1) The application for an NPDES permit shall be signed by a responsible official, as indicated below:
 - (a) In the case of a corporation, by a principal executive officer of at least the level of vice president, or a manager assigned or delegated in accordance with corporate procedures, with such delegation submitted in writing if required by the Department, who is responsible for manufacturing, production, or operating facilities and is authorized to make management decisions which govern the operation of the regulated facility;
 - (b) In the case of a partnership, by a general partner;
 - (c) In the case of a sole proprietorship, by the proprietor; or
 - (d) In the case of a municipal, state, federal, or other public entity, by either a principal executive officer, or ranking elected official.

EPA Identification Number AL0082848	NPDES Permit Number AL0082848	Facility Name Gilbertown WRRF
--	----------------------------------	----------------------------------



Form 2S NPDES		U.S. Environmental Protection Agency Application for NPDES Permit for Sewage Sludge Management NEW AND EXISTING TREATMENT WORKS TREATING DOMESTIC SEWAGE
---------------	--	--

PRELIMINARY INFORMATION

Does your facility currently have an effective NPDES permit or have you been directed by your NPDES permitting authority to submit a full Form 2S permit application?
 Yes → Complete Part 2 of application package (begins p. 7). No → Complete Part 1 of application package (below).

PART 1 LIMITED BACKGROUND INFORMATION (40 CFR 122.21(c)(2)(ii))

Complete this part only if you are a "sludge-only" facility (i.e., a facility that does not currently have, and is not applying for, an NPDES permit for a direct discharge to a surface body of water).

PART 1, SECTION 1. FACILITY INFORMATION (40 CFR 122.21(c)(2)(ii)(A))

Facility Information	1.1	Facility name Gilbertown Water Resources Recovery Facility
		Mailing address (street or P.O. box) 13127 Choctaw Avenue
		City or town Gilbertown
		State Alabama
		ZIP code 36908
		Contact name (first and last) Billy May
		Title Chairman
	Phone number (251) 843-2477	
	Email address kweiss@gilbertownutilities.com	
	Location address (street, route number, or other specific identifier)	<input checked="" type="checkbox"/> Same as mailing address
	City or town	State
	ZIP code	
1.2	Ownership Status	
	<input type="checkbox"/> Public—federal <input type="checkbox"/> Public—state <input checked="" type="checkbox"/> Other public (specify) <u>Municipal</u> <input type="checkbox"/> Private <input type="checkbox"/> Other (specify) _____	

PART 1, SECTION 2. APPLICANT INFORMATION (40 CFR 122.21(c)(2)(ii)(B))

Applicant Information	2.1	Is applicant different from entity listed under Item 1.1 above? <input checked="" type="checkbox"/> Yes <input type="checkbox"/> No → SKIP to Item 2.3 (Part 1, Section 2).
	2.2	Applicant name Utilities Board of the Town of Gilbertown
		Applicant address (street or P.O. box) 13127 Choctaw Avenue
		City or town Gilbertown
		State Alabama
	ZIP code 36908	
	Contact name (first and last) Billy May	
	Title Chairman	
	Phone number (251) 843-2477	
	Email address kweiss@gilbertownutilities.com	
2.3	Is the applicant the facility's owner, operator, or both? (Check only one response.) <input type="checkbox"/> Owner <input type="checkbox"/> Operator <input checked="" type="checkbox"/> Both	
2.4	To which entity should the NPDES permitting authority send correspondence? (Check only one response.) <input type="checkbox"/> Facility <input type="checkbox"/> Applicant <input checked="" type="checkbox"/> Facility and applicant (they are one and the same)	

PART 1, SECTION 3. SEWAGE SLUDGE AMOUNT (40 CFR 122.21(c)(2)(ii)(D))

Sewage Sludge Amount	3.1	Provide the total dry metric tons per the latest 365-day period of sewage sludge generated, treated, used, and disposed of:	
		Practice	Dry Metric Tons per 365-Day Period
		Amount generated at the facility	2.82
		Amount treated at the facility	0
		Amount used (i.e., received from off site) at the facility	0
		Amount disposed of at the facility	0

PART 1, SECTION 4. POLLUTANT CONCENTRATIONS (40 CFR 122.21(c)(2)(ii)(E))

Pollutant Concentrations

4.1 Using the table below or a separate attachment, provide existing sewage sludge monitoring data for the pollutants for which limits in sewage sludge have been established in 40 CFR 503 for your facility's expected use or disposal practices. If available, base data on three or more samples taken at least one month apart and no more than 4.5 years old.

Check here if you have provided a separate attachment with this information.

Pollutant	Concentration (mg/kg dry weight)	Analytical Method	Detection Level for Analysis
Arsenic	24.1	SW6010-B	24.1
Cadmium	<2.41	SW6010-B	2.41
Chromium	<24.1	SW6010-B	24.1
Copper	422	SW6010-B	24.1
Lead	<12.1	SW6010-B	12.1
Mercury	2.41	SW7471-A	2.41
Molybdenum	<121	SW6010-B	121
Nickel	<121	SW6010-B	121
Selenium	<24.1	SW6010-B	24.1
Zinc	570	SW6010-B	121
Other (specify)			
Other (specify)			
Other (specify)			
Other (specify)			
Other (specify)			
Other (specify)			
Other (specify)			
Other (specify)			
Other (specify)			
Other (specify)			

EPA Identification Number AL0082848	NPDES Permit Number AL0082848	Facility Name Gilbertown WRRF
--	----------------------------------	----------------------------------

PART 1, SECTION 5. TREATMENT PROVIDED AT YOUR FACILITY (40 CFR 122.21(c)(2)(ii)(C))

Treatment Provided at Your Facility	5.1	For each sewage sludge use or disposal practice, indicate the amount of sewage sludge used or disposed of, the applicable pathogen class and reduction alternative, and the applicable vector attraction reduction option. Attach additional pages, as necessary.			
		Use or Disposal Practice (check one)	Amount (dry metric tons)	Pathogen Class and Reduction Alternative	Vector Attraction Reduction Option
		<input type="checkbox"/> Land application of bulk sewage <input type="checkbox"/> Land application of biosolids (bulk) <input type="checkbox"/> Land application of biosolids (bags) <input type="checkbox"/> Surface disposal in a landfill <input type="checkbox"/> Other surface disposal <input type="checkbox"/> Incineration		<input type="checkbox"/> Not applicable <input type="checkbox"/> Class A, Alternative 1 <input type="checkbox"/> Class A, Alternative 2 <input type="checkbox"/> Class A, Alternative 3 <input type="checkbox"/> Class A, Alternative 4 <input type="checkbox"/> Class A, Alternative 5 <input type="checkbox"/> Class A, Alternative 6 <input type="checkbox"/> Class B, Alternative 1 <input type="checkbox"/> Class B, Alternative 2 <input type="checkbox"/> Class B, Alternative 3 <input type="checkbox"/> Class B, Alternative 4 <input type="checkbox"/> Domestic septage, pH adjustment	<input type="checkbox"/> Not applicable <input type="checkbox"/> Option 1 <input type="checkbox"/> Option 2 <input type="checkbox"/> Option 3 <input type="checkbox"/> Option 4 <input type="checkbox"/> Option 5 <input type="checkbox"/> Option 6 <input type="checkbox"/> Option 7 <input type="checkbox"/> Option 8 <input type="checkbox"/> Option 9 <input type="checkbox"/> Option 10 <input type="checkbox"/> Option 11
	5.2	For each of the use and disposal practices specified in Item 5.1, identify the treatment process(es) used at your facility to reduce pathogens in sewage sludge or reduce the vector attraction properties of sewage sludge. (Check all that apply.)			
		<input type="checkbox"/> Preliminary operations (e.g., sludge grinding and degritting) <input type="checkbox"/> Stabilization <input type="checkbox"/> Composting <input type="checkbox"/> Disinfection (e.g., beta ray irradiation, gamma ray irradiation, pasteurization) <input type="checkbox"/> Heat drying <input type="checkbox"/> Methane or biogas capture and recovery	<input type="checkbox"/> Thickening (concentration) <input type="checkbox"/> Anaerobic digestion <input type="checkbox"/> Conditioning <input type="checkbox"/> Dewatering (e.g., centrifugation, sludge drying beds, sludge lagoons) <input type="checkbox"/> Thermal reduction <input type="checkbox"/> Other (specify) _____		

PART 1, SECTION 6. SEWAGE SLUDGE SENT TO OTHER FACILITIES (40 CFR 122.21(c)(2)(ii)(C))

Sewage Sludge Sent to Other Facilities	6.1	Does the sewage sludge from your facility meet the ceiling concentrations in Table 1 of 40 CFR 503.13, the pollutant concentrations in Table 3 of 40 CFR 503.13, Class A pathogen reduction requirements at 40 CFR 503.32(a), and one of the vector attraction reduction requirements at 40 CFR 503.33(b)(1)-(8)?			
		<input type="checkbox"/> Yes → SKIP to Part 1, Section 8 (Certification). <input checked="" type="checkbox"/> No			
	6.2	Is sewage sludge from your facility provided to another facility for treatment, distribution, use, or disposal?			
		<input checked="" type="checkbox"/> Yes <input type="checkbox"/> No → SKIP to Part 1, Section 7.			
	6.3	Receiving facility name			
	Meridian WWTP				
	Mailing address (street or P.O. box)				
	2304 Hwy 11 South				
	City or town		State	ZIP code	
	Meridian		MS	39307	
	Contact name (first and last)	Title	Phone number	Email address	
	Mitchell Johnson	Chief Utility Plant Operat	601-485-1815	mitchelljohnson@meridian	
6.4	Which activities does the receiving facility provide? (Check all that apply.)				
	<input checked="" type="checkbox"/> Treatment or blending <input type="checkbox"/> Land application <input type="checkbox"/> Incineration <input type="checkbox"/> Composting		<input type="checkbox"/> Sale or give-away in bag or other container <input type="checkbox"/> Surface disposal <input type="checkbox"/> Other (describe)		

PART 1, SECTION 7. USE AND DISPOSAL SITES (40 CFR 122.21(c)(2)(ii)(C))

Use and Disposal Sites	Provide the following information for each site on which sewage sludge from this facility is used or disposed of.			
	<input type="checkbox"/> Check here if you have provided separate attachments with this information.			
	7.1	Site name or number Meridian WWTP		
	Mailing address (street or P.O. box) 2304 Hwy 11 South			
	City or town Meridian		State MS	ZIP code 39307
	Contact name (first and last) Mitchell Johnson		Title Chief Utility Plant Operator	Phone number (601) 485-1815
	Location address (street, route number, or other specific identifier)			Email address mitchelljohnson@meridian.ms.gov
				<input checked="" type="checkbox"/> Same as mailing address
City or town		State	ZIP code	
County Lauderdale		County code	<input checked="" type="checkbox"/> Not available	
7.2	Site type (check all that apply)			
<input type="checkbox"/> Agricultural <input type="checkbox"/> Lawn or home garden <input type="checkbox"/> Forest <input type="checkbox"/> Surface disposal <input type="checkbox"/> Public contact <input type="checkbox"/> Incineration <input type="checkbox"/> Reclamation <input type="checkbox"/> Municipal solid waste landfill <input checked="" type="checkbox"/> Other (describe) Added to Influent of WWTP				

PART 1, SECTION 8. CHECKLIST AND CERTIFICATION STATEMENT (40 CFR 122.22(a) and (d))

Checklist and Certification Statement	8.1	In Column 1 below, mark the sections of Form 2S, Part 1, that you have completed and are submitting with your application. For each section, specify in Column 2 any attachments that you are enclosing to alert the permitting authority. Note that not all applicants are required to provide attachments.	
	Column 1		Column 2
	<input checked="" type="checkbox"/>	Section 1: Facility Information	<input type="checkbox"/> w/ attachments
	<input checked="" type="checkbox"/>	Section 2: Applicant Information	<input type="checkbox"/> w/ attachments
	<input checked="" type="checkbox"/>	Section 3: Sewage Sludge Amount	<input type="checkbox"/> w/ attachments
	<input checked="" type="checkbox"/>	Section 4: Pollutant Concentrations	<input type="checkbox"/> w/ attachments
	<input checked="" type="checkbox"/>	Section 5: Treatment Provided at Your Facility	<input type="checkbox"/> w/ attachments
	<input checked="" type="checkbox"/>	Section 6: Sewage Sludge Sent to Other Facilities	<input type="checkbox"/> w/ attachments
	<input checked="" type="checkbox"/>	Section 7: Use and Disposal Sites	<input type="checkbox"/> w/ attachments
<input type="checkbox"/>	Section 8: Checklist and Certification Statement		

EPA Identification Number AL0082848		NPDES Permit Number AL0082848	Facility Name Gilbertown WRRF	Form Approved 03/05/19 OMB No. 2040-0004
Checklist and Certification Statement Continued	8.2	Certification Statement <i>I certify under penalty of law that this document and all attachments were prepared under my direction or supervision in accordance with a system designed to assure that qualified personnel properly gather and evaluate the information submitted. Based on my inquiry of the person or persons who manage the system, or those persons directly responsible for gathering the information, the information submitted is, to the best of my knowledge and belief, true, accurate, and complete. I am aware that there are significant penalties for submitting false information, including the possibility of fine and imprisonment for knowing violations.</i>		
		Name (print or type first and last name) Billy May	Official title Chairman, Utilities Board	Phone number (251) 843-2477
		Signature <i>Billy C. May</i>		Date signed 5-1-20

PART 1 APPLICANTS STOP HERE.

Submit completed application package to your NPDES permitting authority.

EPA Identification Number AL0082848		NPDES Permit Number AL0082848	Facility Name Gilbertown WRRF	Form Approved 03/05/19 OMB No. 2040-0004
Checklist and Certification Statement Continued	8.2	Certification Statement <i>I certify under penalty of law that this document and all attachments were prepared under my direction or supervision in accordance with a system designed to assure that qualified personnel properly gather and evaluate the information submitted. Based on my inquiry of the person or persons who manage the system, or those persons directly responsible for gathering the information, the information submitted is, to the best of my knowledge and belief, true, accurate, and complete. I am aware that there are significant penalties for submitting false information, including the possibility of fine and imprisonment for knowing violations.</i>		
		Name (print or type first and last name) Billy May	Official title Chairman, Utilities Board	Phone number (251) 843-2477
		Signature		Date signed

PART 1 APPLICANTS STOP HERE.

Submit completed application package to your NPDES permitting authority.

This page intentionally left blank.

PART 2	PERMIT APPLICATION INFORMATION (40 CFR 122.21(q))
---------------	--

Complete this part if you have an effective NPDES permit or have been directed by the NPDES permitting authority to submit a full permit application. In other words, complete this part if your facility has, or is applying for, an NPDES permit. Part 2 is divided into five sections. Section 1 pertains to all applicants. The applicability of Sections 2 to 5 depends on your facility's sewage sludge use or disposal practices. See the instructions to determine which sections you are required to complete.

PART 2, SECTION 1. GENERAL INFORMATION (40 CFR 122.21(q)(1 7) AND (q)(13))

All Part 2 applicants must complete this section.					
Facility Information					
General Information	1.1	Facility name Gilbertown Water Resources Recovery Facility			
		Mailing address (street or P.O. box) 13127 Choctaw Avenue			
		City or town Gilbertown	State Alabama	ZIP code 3908	Phone number (251) 843-2477
		Contact name (first and last) Billy May	Title Chairman	Email address kweiss@gilbertownutilities.com	
		Location address (street, route number, or other specific identifier) <input checked="" type="checkbox"/> Same as mailing address			
		City or town	State	ZIP code	
	1.2	Is this facility a Class I sludge management facility? <input type="checkbox"/> Yes <input checked="" type="checkbox"/> No			
	1.3	Facility Design Flow Rate	0.060 million gallons per day (mgd)		
	1.4	Total Population Served	187		
	1.5	Ownership Status <input type="checkbox"/> Public—federal <input type="checkbox"/> Public—state <input checked="" type="checkbox"/> Other public (specify) <u>Municipal</u> <input type="checkbox"/> Private <input type="checkbox"/> Other (specify) _____			
Applicant Information					
1.6	Is applicant different from entity listed under Item 1.1 above? <input checked="" type="checkbox"/> Yes <input type="checkbox"/> No → SKIP to Item 1.8 (Part 2, Section 1).				
1.7	Applicant name Utilities Board of the Town of Gilbertown				
	Applicant mailing address (street or P.O. box) 13127 Choctaw Avenue				
	City or town Gilbertown	State Alabama	ZIP code 36908		
	Contact name (first and last) Billy May	Title Chairman	Phone number (251) 843-2477		
	Email address kweiss@gilbertownutiliti				
1.8	Is the applicant the facility's owner, operator, or both? (Check only one response.) <input type="checkbox"/> Operator <input type="checkbox"/> Owner <input checked="" type="checkbox"/> Both				
1.9	To which entity should the NPDES permitting authority send correspondence? (Check only one response.) <input type="checkbox"/> Facility <input type="checkbox"/> Applicant <input checked="" type="checkbox"/> Facility and applicant (they are one and the same)				

EPA Identification Number AL0082848		NPDES Permit Number AL0082848		Facility Name Gilbertown WRRF		Form Approved 03/05/19 OMB No. 2040-0004	
1.10		Facility's NPDES permit number <input type="checkbox"/> Check here if you do not have an NPDES permit but are otherwise required to submit Part 2 of Form 2S.				AL0082848	
1.11		Indicate all other federal, state, and local permits or construction approvals received or applied for that regulate this facility's sewage sludge management practices below.					
		<input type="checkbox"/> RCRA (hazardous wastes)		<input type="checkbox"/> Nonattainment program (CAA)		<input type="checkbox"/> NESHAPs (CAA)	
		<input type="checkbox"/> PSD (air emissions)		<input type="checkbox"/> Dredge or fill (CWA Section 404)		<input type="checkbox"/> Other (specify)	
		<input type="checkbox"/> Ocean dumping (MPRSA)		<input type="checkbox"/> UIC (underground injection of fluids)			
Indian Country							
1.12		Does any generation, treatment, storage, application to land, or disposal of sewage sludge from this facility occur in Indian Country? <input type="checkbox"/> Yes <input checked="" type="checkbox"/> No → SKIP to Item 1.14 (Part 2, Section 1) below.					
1.13		Provide a description of the generation, treatment, storage, land application, or disposal of sewage sludge that occurs.					
Topographic Map							
1.14		Have you attached a topographic map containing all required information to this application? (See instructions for specific requirements.) <input checked="" type="checkbox"/> Yes <input type="checkbox"/> No					
Line Drawing							
1.15		Have you attached a line drawing and/or a narrative description that identifies all sewage sludge practices that will be employed during the term of the permit containing all the required information to this application? (See instructions for specific requirements.) <input checked="" type="checkbox"/> Yes <input type="checkbox"/> No					
Contractor Information							
1.16		Do contractors have any operational or maintenance responsibilities related to sewage sludge generation, treatment, use, or disposal at the facility? <input checked="" type="checkbox"/> Yes <input type="checkbox"/> No → SKIP to Item 1.18 (Part 2, Section 1) below.					
1.17		Provide the following information for each contractor. <input type="checkbox"/> Check here if you have attached additional sheets to the application package.					
		Contractor 1		Contractor 2		Contractor 3	
		Contractor company name		Wilson Septic Tank Service			
		Mailing address (street or P.O. box)		3456 Linton Road			
		City, state, and ZIP code		Meridian, MS 39301			
		Contact name (first and last)		Michael Wilson			
		Telephone number		(601) 644-3445			
		Email address					

General Information Continued

1.17 cont.		Contractor 1	Contractor 2	Contractor 3
	Responsibilities of contractor	Trucking and disposal of Waste Sludge		

Pollutant Concentrations

Using the table below or a separate attachment, provide sewage sludge monitoring data for the pollutants for which limits in sewage sludge have been established in 40 CFR 503 for this facility's expected use or disposal practices. All data must be based on three or more samples taken at least one month apart and must be no more than 4.5 years old.

Check here if you have attached additional sheets to the application package.

1.18	Pollutant	Average Monthly Concentration (mg/kg dry weight)	Analytical Method	Detection Level
	Arsenic	N/A		
	Cadmium	N/A		
	Chromium	N/A		
	Copper	N/A		
	Lead	N/A		
	Mercury	N/A		
	Molybdenum	N/A		
	Nickel	N/A		
	Selenium	N/A		
	Zinc	N/A		

Checklist and Certification Statement

1.19 In Column 1 below, mark the sections of Form 2S, Part 2, that you have completed and are submitting with your application. For each section, specify in Column 2 any attachments that you are enclosing. Note that not all applicants are required to complete all sections or provide attachments. See Exhibit 2S-2 in the Instructions.

Column 1	Column 2
<input checked="" type="checkbox"/> Section 1 (General Information)	<input type="checkbox"/> w/ attachments
<input checked="" type="checkbox"/> Section 2 (Generation of Sewage Sludge or Preparation of a Material Derived from Sewage Sludge)	<input type="checkbox"/> w/ attachments
<input checked="" type="checkbox"/> Section 3 (Land Application of Bulk Sewage Sludge)	<input type="checkbox"/> w/ attachments
<input checked="" type="checkbox"/> Section 4 (Surface Disposal)	<input type="checkbox"/> w/ attachments
<input checked="" type="checkbox"/> Section 5 (Incineration)	<input type="checkbox"/> w/ attachments

1.20 **Certification Statement**

I certify under penalty of law that this document and all attachments were prepared under my direction or supervision in accordance with a system designed to assure that qualified personnel properly gather and evaluate the information submitted. Based on my inquiry of the person or persons who manage the system, or those persons directly responsible for gathering the information, the information submitted is, to the best of my knowledge and belief, true, accurate, and complete. I am aware that there are significant penalties for submitting false information, including the possibility of fine and imprisonment for knowing violations.

Name (print or type first and last name) Billy May	Official title Chairman
Signature <i>Billy L. May</i>	Date signed 5-1-20
Telephone number (251) 843-2477	

Upon the request of the NPDES permitting authority, you must submit any other information the authority deems necessary to assess sewage sludge use or disposal practices at your facility and identify appropriate permitting requirements.

EPA Identification Number
AL0082848

NPDES Permit Number
AL0082848

Facility Name
Gilbertown WRRF

Form Approved 03/05/19
OMB No. 2040-0004

1.17 cont.		Contractor 1	Contractor 2	Contractor 3
	Responsibilities of contractor	Trucking and disposal of Waste Sludge		

Pollutant Concentrations

Using the table below or a separate attachment, provide sewage sludge monitoring data for the pollutants for which limits in sewage sludge have been established in 40 CFR 503 for this facility's expected use or disposal practices. All data must be based on three or more samples taken at least one month apart and must be no more than 4.5 years old.

Check here if you have attached additional sheets to the application package.

1.18	Pollutant	Average Monthly Concentration (mg/kg dry weight)	Analytical Method	Detection Level
	Arsenic	N/A		
	Cadmium	N/A		
	Chromium	N/A		
	Copper	N/A		
	Lead	N/A		
	Mercury	N/A		
	Molybdenum	N/A		
	Nickel	N/A		
	Zinc	N/A		

Checklist and Certification Statement

1.19	In Column 1 below, mark the sections of Form 2S, Part 2, that you have completed and are submitting with your application. For each section, specify in Column 2 any attachments that you are enclosing. Note that not all applicants are required to complete all sections or provide attachments. See Exhibit 2S-2 in the Instructions.	
	Column 1	Column 2
	<input checked="" type="checkbox"/> Section 1 (General Information)	<input type="checkbox"/> w/ attachments
	<input checked="" type="checkbox"/> Section 2 (Generation of Sewage Sludge or Preparation of a Material Derived from Sewage Sludge)	<input type="checkbox"/> w/ attachments
	<input checked="" type="checkbox"/> Section 3 (Land Application of Bulk Sewage Sludge)	<input type="checkbox"/> w/ attachments
	<input checked="" type="checkbox"/> Section 4 (Surface Disposal)	<input type="checkbox"/> w/ attachments
<input checked="" type="checkbox"/> Section 5 (Incineration)	<input type="checkbox"/> w/ attachments	

1.20	Certification Statement	
	<i>I certify under penalty of law that this document and all attachments were prepared under my direction or supervision in accordance with a system designed to assure that qualified personnel properly gather and evaluate the information submitted. Based on my inquiry of the person or persons who manage the system, or those persons directly responsible for gathering the information, the information submitted is, to the best of my knowledge and belief, true, accurate, and complete. I am aware that there are significant penalties for submitting false information, including the possibility of fine and imprisonment for knowing violations.</i>	
	Name (print or type first and last name) Billy May	Official title Chairman
	Signature	Date signed
	Telephone number (251) 843-2477	

Upon the request of the NPDES permitting authority, you must submit any other information the authority deems necessary to assess sewage sludge use or disposal practices at your facility and identify appropriate permitting requirements.

General Information Continued

EPA Identification Number
AL0082848

NPDES Permit Number
AL0082848

Facility Name
Gilberttown WRRF

Form Approved 03/05/19
OMB No. 2040-0004

PART 2, SECTION 2. GENERATION OF SEWAGE SLUDGE OR PREPARATION OF A MATERIAL DERIVED FROM SEWAGE SLUDGE (40 CFR 122.21(q)(8) THROUGH (12))

Generation of Sewage Sludge or Preparation of a Material Derived from Sewage Sludge	2.1	Does your facility generate sewage sludge or derive a material from sewage sludge? <input checked="" type="checkbox"/> Yes <input type="checkbox"/> No → SKIP to Part 2, Section 3.		
	Amount Generated Onsite			
	2.2	Total dry metric tons per 365-day period generated at your facility:		2.82 dry metric tons/year
	Amount Received from Off Site Facility			
	2.3	Does your facility receive sewage sludge from another facility for treatment use or disposal? <input type="checkbox"/> Yes <input checked="" type="checkbox"/> No → SKIP to Item 2.7 (Part 2, Section 2) below.		
	2.4	Indicate the total number of facilities from which you receive sewage sludge for treatment, use, or disposal:		
	Provide the following information for each of the facilities from which you receive sewage sludge. <input type="checkbox"/> Check here if you have attached additional sheets to the application package.			
	2.5	Name of facility N/A		
		Mailing address (street or P.O. box)		
		City or town		State
Contact name (first and last)		Title	Phone number	Email address
Location address (street, route number, or other specific identifier)			<input type="checkbox"/> Same as mailing address	
City or town		State	ZIP code	
County		County code <input type="checkbox"/> Not available		
2.6		Indicate the amount of sewage sludge received, the applicable pathogen class and reduction alternative, and the applicable vector reduction option provided at the offsite facility.		
	Amount (dry metric tons)	Pathogen Class and Reduction Alternative	Vector Attraction Reduction Option	
		<input type="checkbox"/> Not applicable <input type="checkbox"/> Class A, Alternative 1 <input type="checkbox"/> Class A, Alternative 2 <input type="checkbox"/> Class A, Alternative 3 <input type="checkbox"/> Class A, Alternative 4 <input type="checkbox"/> Class A, Alternative 5 <input type="checkbox"/> Class A, Alternative 6 <input type="checkbox"/> Class B, Alternative 1 <input type="checkbox"/> Class B, Alternative 2 <input type="checkbox"/> Class B, Alternative 3 <input type="checkbox"/> Class B, Alternative 4 <input type="checkbox"/> Domestic septage, pH adjustment	<input type="checkbox"/> Not applicable <input type="checkbox"/> Option 1 <input type="checkbox"/> Option 2 <input type="checkbox"/> Option 3 <input type="checkbox"/> Option 4 <input type="checkbox"/> Option 5 <input type="checkbox"/> Option 6 <input type="checkbox"/> Option 7 <input type="checkbox"/> Option 8 <input type="checkbox"/> Option 9 <input type="checkbox"/> Option 10 <input type="checkbox"/> Option 11	
2.7	Identify the treatment process(es) that are known to occur at the offsite facility, including blending activities and treatment to reduce pathogens or vector attraction properties. (Check all that apply.)			
	<input type="checkbox"/> Preliminary operations (e.g., sludge grinding and dewatering)	<input type="checkbox"/> Thickening (concentration)		
	<input type="checkbox"/> Stabilization	<input type="checkbox"/> Anaerobic digestion		
	<input type="checkbox"/> Composting	<input type="checkbox"/> Conditioning		
	<input type="checkbox"/> Disinfection (e.g., beta ray irradiation, gamma ray irradiation, pasteurization)	<input type="checkbox"/> Dewatering (e.g., centrifugation, sludge drying beds, sludge lagoons)		
	<input type="checkbox"/> Heat drying	<input type="checkbox"/> Thermal reduction		
	<input type="checkbox"/> Methane or biogas capture and recovery	<input checked="" type="checkbox"/> Other (specify) <u>Added to Treatment Process</u>		

Generation of Sewage Sludge or Preparation of a Material Derived from Sewage Sludge Continued	Treatment Provided at Your Facility			
	2.8	For each sewage sludge use or disposal practice, indicate the applicable pathogen class and reduction alternative and the applicable vector attraction reduction option provided at your facility. Attach additional pages, as necessary.		
		Use or Disposal Practice (check one)	Pathogen Class and Reduction Alternative	Vector Attraction Reduction Option
		<input type="checkbox"/> Land application of bulk sewage <input type="checkbox"/> Land application of biosolids (bulk) <input type="checkbox"/> Land application of biosolids (bags) <input type="checkbox"/> Surface disposal in a landfill <input type="checkbox"/> Other surface disposal <input type="checkbox"/> Incineration	<input checked="" type="checkbox"/> Not applicable <input type="checkbox"/> Class A, Alternative 1 <input type="checkbox"/> Class A, Alternative 2 <input type="checkbox"/> Class A, Alternative 3 <input type="checkbox"/> Class A, Alternative 4 <input type="checkbox"/> Class A, Alternative 5 <input type="checkbox"/> Class A, Alternative 6 <input type="checkbox"/> Class B, Alternative 1 <input type="checkbox"/> Class B, Alternative 2 <input type="checkbox"/> Class B, Alternative 3 <input type="checkbox"/> Class B, Alternative 4 <input type="checkbox"/> Domestic septage, pH adjustment	<input checked="" type="checkbox"/> Not applicable <input type="checkbox"/> Option 1 <input type="checkbox"/> Option 2 <input type="checkbox"/> Option 3 <input type="checkbox"/> Option 4 <input type="checkbox"/> Option 5 <input type="checkbox"/> Option 6 <input type="checkbox"/> Option 7 <input type="checkbox"/> Option 8 <input type="checkbox"/> Option 9 <input type="checkbox"/> Option 10 <input type="checkbox"/> Option 11
	2.9	Identify the treatment process(es) used at your facility to reduce pathogens in sewage sludge or reduce the vector attraction properties of sewage sludge? (Check all that apply.)		
		<input type="checkbox"/> Preliminary operations (e.g., sludge grinding and dewatering) <input checked="" type="checkbox"/> Stabilization <input type="checkbox"/> Composting <input type="checkbox"/> Disinfection (e.g., beta ray irradiation, gamma ray irradiation, pasteurization) <input type="checkbox"/> Heat drying <input type="checkbox"/> Methane or biogas capture and recovery	<input type="checkbox"/> Thickening (concentration) <input type="checkbox"/> Anaerobic digestion <input type="checkbox"/> Conditioning <input type="checkbox"/> Dewatering (e.g., centrifugation, sludge drying beds, sludge lagoons) <input type="checkbox"/> Thermal reduction	
	2.10	Describe any other sewage sludge treatment or blending activities not identified in Items 2.8 and 2.9 (Part 2, Section 2) above.		
		<input type="checkbox"/> Check here if you have attached the description to the application package. Sludge is collected as needed (usually weekly) and trucked to the Meridian, MS WWTP. It is added to the influent waste stream and treated in the activated sludge process.		
	Preparation of Sewage Sludge Meeting Ceiling and Pollutant Concentrations, Class A Pathogen Requirements, and One of Vector Attraction Reduction Options 1 to 8			
	2.11	Does the sewage sludge from your facility meet the ceiling concentrations in Table 1 of 40 CFR 503.13, the pollutant concentrations in Table 3 of 40 CFR 503.13, Class A pathogen reduction requirements at 40 CFR 503.32(a), and one of the vector attraction reduction requirements at 40 CFR 503.33(b)(1)–(8) and is it land applied?		
	<input type="checkbox"/> Yes	<input checked="" type="checkbox"/> No → SKIP to Item 2.14 (Part 2, Section 2) below.		
2.12	Total dry metric tons per 365-day period of sewage sludge subject to this subsection that is applied to the land:			
2.13	Is sewage sludge subject to this subsection placed in bags or other containers for sale or give-away for application to the land?			
	<input type="checkbox"/> Yes	<input type="checkbox"/> No		
<input type="checkbox"/> Check here once you have completed Items 2.11 to 2.13, then → SKIP to Item 2.32 (Part 2, Section 2) below.				

EPA Identification Number
AL0082848

NPDES Permit Number
AL0082848

Facility Name
Gilberttown WRRF

Form Approved 03/05/19
OMB No. 2040-0004

Generation of Sewage Sludge or Preparation of a Material Derived from Sewage Sludge Continued

Sale or Give-Away in a Bag or Other Container for Application to the Land

2.14 Do you place sewage sludge in a bag or other container for sale or give-away for land application?
 Yes No → SKIP to Item 2.17 (Part 2, Section 2) below.

2.15 Total dry metric tons per 365-day period of sewage sludge placed in a bag or other container at your facility for sale or give-away for application to the land:

2.16 Attach a copy of all labels or notices that accompany the sewage sludge being sold or given away in a bag or other container for application to the land.
 Check here to indicate that you have attached all labels or notices to this application package.

Check here once you have completed Items 2.14 to 2.16, then → SKIP to Part 2, Section 2, Item 2.32.

Shipment Off Site for Treatment or Blending

2.17 Does another facility provide treatment or blending of your facility's sewage sludge? (This question does not pertain to dewatered sludge sent directly to a land application or surface disposal site.)
 Yes No → SKIP to Item 2.32 (Part 2, Section 2) below.

2.18 Indicate the total number of facilities that provide treatment or blending of your facility's sewage sludge. Provide the information in Items 2.19 to 2.26 (Part 2, Section 2) below for each facility.
 Check here if you have attached additional sheets to the application package.

2.19 Name of receiving facility
Meridian Wastewater Treatment Plant

Mailing address (street or P.O. box)
2304 Highway 11 South

City or town Meridian	State MS	ZIP code 39307
Contact name (first and last) Mitchell Johnson	Title Chief Utility Plant Op.	Phone number (601) 485-1815
Location address (street, route number, or other specific identifier)		<input checked="" type="checkbox"/> Same as mailing address
City or town	State	ZIP code

2.20 Total dry metric tons per 365-day period of sewage sludge provided to receiving facility:
2.82 dry metric tons/year

2.21 Does the receiving facility provide additional treatment to reduce pathogens in sewage sludge from your facility or reduce the vector attraction properties of sewage sludge from your facility?
 Yes No → SKIP to Item 2.24 (Part 2, Section 2) below.

2.22 Indicate the pathogen class and reduction alternative and the vector attraction reduction option met for the sewage sludge at the receiving facility.

Pathogen Class and Reduction Alternative	Vector Attraction Reduction Option
<input checked="" type="checkbox"/> Not applicable	<input checked="" type="checkbox"/> Not applicable
<input type="checkbox"/> Class A, Alternative 1	<input type="checkbox"/> Option 1
<input type="checkbox"/> Class A, Alternative 2	<input type="checkbox"/> Option 2
<input type="checkbox"/> Class A, Alternative 3	<input type="checkbox"/> Option 3
<input type="checkbox"/> Class A, Alternative 4	<input type="checkbox"/> Option 4
<input type="checkbox"/> Class A, Alternative 5	<input type="checkbox"/> Option 5
<input type="checkbox"/> Class A, Alternative 6	<input type="checkbox"/> Option 6
<input type="checkbox"/> Class B, Alternative 1	<input type="checkbox"/> Option 7
<input type="checkbox"/> Class B, Alternative 2	<input type="checkbox"/> Option 8
<input type="checkbox"/> Class B, Alternative 3	<input type="checkbox"/> Option 9
<input type="checkbox"/> Class B, Alternative 4	<input type="checkbox"/> Option 10
<input type="checkbox"/> Domestic septage, pH adjustment	<input type="checkbox"/> Option 11

EPA Identification Number
AL0082848

NPDES Permit Number
AL0082848

Facility Name
Gilbertown WRRF

Form Approved 03/05/19
OMB No. 2040-0004

Generation of Sewage Sludge or Preparation of a Material Derived from Sewage Sludge Continued

2.23	Which treatment process(es) are used at the receiving facility to reduce pathogens in sewage sludge or reduce the vector attraction properties of sewage sludge from your facility? (Check all that apply.)	
	<input type="checkbox"/> Preliminary operations (e.g., sludge grinding and dewatering)	<input type="checkbox"/> Thickening (concentration)
	<input type="checkbox"/> Stabilization	<input type="checkbox"/> Anaerobic digestion
	<input type="checkbox"/> Composting	<input type="checkbox"/> Conditioning
	<input type="checkbox"/> Disinfection (e.g., beta ray irradiation, gamma ray irradiation, pasteurization)	<input type="checkbox"/> Dewatering (e.g., centrifugation, sludge drying beds, sludge lagoons)
	<input type="checkbox"/> Heat drying	<input type="checkbox"/> Thermal reduction
	<input type="checkbox"/> Methane or biogas capture and recovery	<input checked="" type="checkbox"/> Other (specify) <u>Activated Sludge</u>
2.24	Attach a copy of any information you provide the receiving facility to comply with the "notice and necessary information" requirement of 40 CFR 503.12(g).	
	<input type="checkbox"/> Check here to indicate that you have attached material.	
2.25	Does the receiving facility place sewage sludge from your facility in a bag or other container for sale or give-away for application to the land?	
	<input type="checkbox"/> Yes	<input checked="" type="checkbox"/> No → SKIP to Item 2.32 (Part 2, Section 2) below.
2.26	Attach a copy of all labels or notices that accompany the product being sold or given away.	
	<input type="checkbox"/> Check here to indicate that you have attached material.	
	<input checked="" type="checkbox"/> Check here once you have completed Items 2.17 to 2.26 (Part 2, Section 2), then → SKIP to Item 2.32 (Part 2, Section 2) below.	
Land Application of Bulk Sewage Sludge		
2.27	Is sewage sludge from your facility applied to the land?	
	<input type="checkbox"/> Yes	<input checked="" type="checkbox"/> No → SKIP to Item 2.32 (Part 2, Section 2) below.
2.28	Total dry metric tons per 365-day period of sewage sludge applied to all land application sites:	
2.29	Did you identify all land application sites in Part 2, Section 3 of this application?	
	<input type="checkbox"/> Yes	<input type="checkbox"/> No → Submit a copy of the land application plan with your application.
2.30	Are any land application sites located in states other than the state where you generate sewage sludge or derive a material from sewage sludge?	
	<input type="checkbox"/> Yes	<input type="checkbox"/> No → SKIP to Item 2.32 (Part 2, Section 2) below.
2.31	Describe how you notify the NPDES permitting authority for the states where the land application sites are located. Attach a copy of the notification.	
	<input type="checkbox"/> Check here if you have attached the explanation to the application package.	
	<input type="checkbox"/> Check here if you have attached the notification to the application package.	
Surface Disposal		
2.32	Is sewage sludge from your facility placed on a surface disposal site?	
	<input type="checkbox"/> Yes	<input checked="" type="checkbox"/> No → SKIP to Item 2.39 (Part 2, Section 2) below.
2.33	Total dry metric tons of sewage sludge from your facility placed on all surface disposal sites per 365-day period:	
2.34	Do you own or operate all surface disposal sites to which you send sewage sludge for disposal?	
	<input type="checkbox"/> Yes → SKIP to Item 2.39 (Part 2, Section 2) below.	<input type="checkbox"/> No
2.35	Indicate the total number of surface disposal sites to which you send your sewage sludge. (Provide the information in Items 2.36 to 2.38 of Part 2, Section 2, for each facility.)	
	<input type="checkbox"/> Check here if you have attached additional sheets to the application package.	

EPA Identification Number
AL0082848

NPDES Permit Number
AL0082848

Facility Name
Gilberttown WRRF

Form Approved 03/05/19
OMB No. 2040-0004

Generation of Sewage Sludge or Preparation of a Material Derived from Sewage Sludge Continued	2.36	Site name or number of surface disposal site you do not own or operate		
		Mailing address (street or P.O. box)		
		City or Town	State	ZIP Code
		Contact Name (first and last)	Title	Email Address
	2.37	Site Contact (Check all that apply.) <input type="checkbox"/> Owner <input type="checkbox"/> Operator		
	2.38	Total dry metric tons of sewage sludge from your facility placed on this surface disposal site per 365-day period:		
	Incineration			
	2.39	Is sewage sludge from your facility fired in a sewage sludge incinerator? <input type="checkbox"/> Yes <input checked="" type="checkbox"/> No → SKIP to Item 2.46 (Part 2, Section 2) below.		
	2.40	Total dry metric tons of sewage sludge from your facility fired in all sewage sludge incinerators per 365-day period:		
	2.41	Do you own or operate all sewage sludge incinerators in which sewage sludge from your facility is fired? <input type="checkbox"/> Yes → SKIP to Item 2.46 (Part 2, Section 2) below. <input type="checkbox"/> No		
	2.42	Indicate the total number of sewage sludge incinerators used that you do not own or operate. (Provide the information in Items 2.43 to 2.45 directly below for each facility.) <input type="checkbox"/> Check here if you have attached additional sheets to the application package.		
	2.43	Incinerator name or number		
		Mailing address (street or P.O. box)		
		City or town	State	ZIP code
		Contact name (first and last)	Title	Email address
		Location address (street, route number, or other specific identifier)		<input type="checkbox"/> Same as mailing address
		City or town	State	ZIP code
	2.44	Contact (check all that apply) <input type="checkbox"/> Incinerator owner <input type="checkbox"/> Incinerator operator		
	2.45	Total dry metric tons of sewage sludge from your facility fired in this sewage sludge incinerator per 365-day period:		
	Disposal in a Municipal Solid Waste Landfill			
2.46	Is sewage sludge from your facility placed on a municipal solid waste landfill? <input type="checkbox"/> Yes <input checked="" type="checkbox"/> No → SKIP to Part 2, Section 3.			
2.47	Indicate the total number of municipal solid waste landfills used. (Provide the information in Items 2.48 to 2.52 directly below for each facility.) <input type="checkbox"/> Check here if you have attached additional sheets to the application package.			

EPA Identification Number AL0082848		NPDES Permit Number AL0082848		Facility Name Gilbertown WRRF		Form Approved 03/05/19 OMB No. 2040-0004		
Generation of Sewage Sludge or Preparation of a Material Derived from Sewage Sludge Continued	2.48	Name of landfill						
		Mailing address (street or P.O. box)						
		City or town			State		ZIP code	
		Contact name (first and last)		Title		Phone number		Email address
		Location address (street, route number, or other specific identifier)						<input type="checkbox"/> Same as mailing address
		County			County code			<input type="checkbox"/> Not available
		City or town			State		ZIP code	
	2.49	Total dry metric tons of sewage sludge from your facility placed in this municipal solid waste landfill per 365-day period:						
	2.50	List the numbers of all other federal, state, and local permits that regulate the operation of this municipal solid waste landfill.						
		Permit Number		Type of Permit				
2.51	Attach to the application information to determine whether the sewage sludge meets applicable requirements for disposal of sewage sludge in a municipal solid waste landfill (e.g., results of paint filter liquids test and TCLP test). <input type="checkbox"/> Check here to indicate you have attached the requested information.							
2.52	Does the municipal solid waste landfill comply with applicable criteria set forth in 40 CFR 258? <input type="checkbox"/> Yes <input type="checkbox"/> No							

EPA Identification Number
AL0082848

NPDES Permit Number
AL0082848

Facility Name
Gilbertown WRRF

Form Approved 03/05/19
OMB No. 2040-0004

PART 2, SECTION 3 LAND APPLICATION OF BULK SEWAGE SLUDGE (40 CFR 122.21(q)(9))

Land Application of Bulk Sewage Sludge

3.1 Does your facility apply sewage sludge to land?
 Yes No → SKIP to Part 2, Section 4.

3.2 Do any of the following conditions apply?
• The sewage sludge meets the ceiling concentrations in Table 1 of 40 CFR 503.12, the pollutant concentrations in Table 3 of 40 CFR 503.13, Class A pathogen reduction requirements at 40 CFR 503.32(a), and one of the vector attraction reduction requirements at 40 CFR 503.33(b)(1)–(8);
• The sewage sludge is sold or given away in a bag or other container for application to the land; or
• You provide the sewage sludge to another facility for treatment or blending.
 Yes → SKIP to Part 2, Section 4. No

3.3 Complete Section 3 for every site on which the sewage sludge is applied.
 Check here if you have attached sheets to the application package for one or more land application sites.

Identification of Land Application Site

3.4 Site name or number

Location address (street, route number, or other specific identifier) Same as mailing address

County County code Not available

City or town State ZIP code

Latitude/Longitude of Land Application Site (see instructions)

Latitude Longitude

Latitude Longitude

Method of Determination

USGS map Field survey Other (specify) _____

3.5 Provide a topographic map (or other appropriate map if a topographic map is unavailable) that shows the site location.
 Check here to indicate you have attached a topographic map for this site.

Owner Information

3.6 Are you the owner of this land application site?
 Yes → SKIP to Item 3.8 (Part 2, Section 3) below. No

3.7 Owner name

Mailing address (street or P.O. box)

City or town State ZIP code

Contact name (first and last) Title Phone number Email address

Applier Information

3.8 Are you the person who applies, or who is responsible for application of, sewage sludge to this land application site?
 Yes → SKIP to Item 3.10 (Part 2, Section 3) below. No

3.9 Applier's name

Mailing address (street or P.O. box)

City or town State ZIP code

Contact name (first and last) Title Phone number Email address

EPA Identification Number
AL0082848

NPDES Permit Number
AL0082848

Facility Name
Gilbertown WRRF

Form Approved 03/05/19
OMB No. 2040-0004

PART 2, SECTION 4 SURFACE DISPOSAL (40 CFR 122.21(q)(10))

Surface Disposal

4.1	Do you own or operate a surface disposal site? <input type="checkbox"/> Yes <input checked="" type="checkbox"/> No → SKIP to Part 2, Section 5.		
4.2	Complete all items in Section 4 for each active sewage sludge unit that you own or operate. <input type="checkbox"/> Check here to indicate that you have attached material to the application package for one or more active sewage sludge units.		
Information on Active Sewage Sludge Units			
4.3	Unit name or number		
	Mailing address (street or P.O. box)		
	City or town	State	ZIP code
	Contact name (first and last)	Title	Phone number Email address
	Location address (street, route number, or other specific identifier)		<input type="checkbox"/> Same as mailing address
	County	County code	<input type="checkbox"/> Not available
	City or town	State	ZIP code
Latitude/Longitude of Active Sewage Sludge Unit (see instructions)			
	Latitude		Longitude
	" " "		" " "
Method of Determination			
	<input type="checkbox"/> USGS map <input type="checkbox"/> Field survey <input type="checkbox"/> Other (specify) _____		
4.4	Provide a topographic map (or other appropriate map if a topographic map is unavailable) that shows the site location. <input type="checkbox"/> Check here to indicate that you have completed and attached a topographic map.		
4.5	Total dry metric tons of sewage sludge placed on the active sewage sludge unit per 365-day period:		
4.6	Total dry metric tons of sewage sludge placed on the active sewage sludge unit over the life of the unit:		
4.7	Does the active sewage sludge unit have a liner with a maximum permeability of 1×10^{-7} centimeters per second (cm/sec)? <input type="checkbox"/> Yes <input type="checkbox"/> No → SKIP to Item 4.9 (Part 2, Section 4) below.		
4.8	Describe the liner. <input type="checkbox"/> Check here to indicate that you have attached a description to the application package.		
4.9	Does the active sewage sludge unit have a leachate collection system? <input type="checkbox"/> Yes <input type="checkbox"/> No → SKIP to Item 4.11 (Part 2, Section 4) below.		
4.10	Describe the leachate collection system and the method used for leachate disposal and provide the numbers of any federal, state, or local permit(s) for leachate disposal. <input type="checkbox"/> Check here to indicate that you have attached the description to the application package.		

EPA Identification Number
AL0082848

NPDES Permit Number
AL0082848

Facility Name
Gilbertown WRRF

Form Approved 03/05/19
OMB No. 2040-0004

Surface Disposal Continued	4.11	Is the boundary of the active sewage sludge unit less than 150 meters from the property line of the surface disposal site?		
		<input type="checkbox"/> Yes	<input type="checkbox"/> No → SKIP to Item 4.13 (Part 2, Section 4) below.	
	4.12	Provide the actual distance in meters:		_____ meters
	4.13	Remaining capacity of active sewage sludge unit in dry metric tons:		_____ dry metric tons
	4.14	Anticipated closure date for active sewage sludge unit, if known (MM/DD/YYYY): _____		
	4.15	Attach a copy of any closure plan that has been developed for this active sewage sludge unit. <input type="checkbox"/> Check here to indicate that you have attached a copy of the closure plan to the application package.		
	Sewage Sludge from Other Facilities			
	4.16	Is sewage sludge sent to this active sewage sludge unit from any facilities other than your facility? <input type="checkbox"/> Yes <input type="checkbox"/> No → SKIP to Item 4.21 (Part 2, Section 4) below.		
	4.17	Indicate the total number of facilities (other than your facility) that send sewage sludge to this active sewage sludge unit. (Complete Items 4.18 to 4.20 directly below for each such facility.) <input type="checkbox"/> Check here to indicate that you have attached responses for each facility to the application package.		
	4.18	Facility name _____		
		Mailing address (street or P.O. box) _____		
		City or town _____	State _____	ZIP code _____
		Contact name (first and last) _____	Title _____	Phone number _____ Email address _____
	4.19	Indicate the pathogen class and reduction alternative and the vector attraction reduction option met for the sewage sludge before leaving the other facility.		
Pathogen Class and Reduction Alternative		Vector Attraction Reduction Option		
4.20	<input type="checkbox"/> Not applicable <input type="checkbox"/> Class A, Alternative 1 <input type="checkbox"/> Class A, Alternative 2 <input type="checkbox"/> Class A, Alternative 3 <input type="checkbox"/> Class A, Alternative 4 <input type="checkbox"/> Class A, Alternative 5 <input type="checkbox"/> Class A, Alternative 6 <input type="checkbox"/> Class B, Alternative 1 <input type="checkbox"/> Class B, Alternative 2 <input type="checkbox"/> Class B, Alternative 3 <input type="checkbox"/> Class B, Alternative 4 <input type="checkbox"/> Domestic septage, pH adjustment			
	<input type="checkbox"/> Not applicable <input type="checkbox"/> Option 1 <input type="checkbox"/> Option 2 <input type="checkbox"/> Option 3 <input type="checkbox"/> Option 4 <input type="checkbox"/> Option 5 <input type="checkbox"/> Option 6 <input type="checkbox"/> Option 7 <input type="checkbox"/> Option 8 <input type="checkbox"/> Option 9 <input type="checkbox"/> Option 10 <input type="checkbox"/> Option 11			
4.20	Which treatment process(es) are used at the other facility to reduce pathogens in sewage sludge or reduce the vector attraction properties of sewage sludge before leaving the other facility? (Check all that apply.)			
	<input type="checkbox"/> Preliminary operations (e.g., sludge grinding and degritting) <input type="checkbox"/> Stabilization <input type="checkbox"/> Composting <input type="checkbox"/> Disinfection (e.g., beta ray irradiation, gamma ray irradiation, pasteurization) <input type="checkbox"/> Heat drying <input type="checkbox"/> Methane or biogas capture and recovery	<input type="checkbox"/> Thickening (concentration) <input type="checkbox"/> Anaerobic digestion <input type="checkbox"/> Conditioning <input type="checkbox"/> Dewatering (e.g., centrifugation, sludge drying beds, sludge lagoons) <input type="checkbox"/> Thermal reduction <input type="checkbox"/> Other (specify) _____		

EPA Identification Number AL0082848		NPDES Permit Number AL0082848		Facility Name Gilbertown WRRF		Form Approved 03/05/19 OMB No. 2040-0004	
Surface Disposal Continued	Vector Attraction Reduction						
	4.21	Which vector attraction reduction option, if any, is met when sewage sludge is placed on this active sewage sludge unit?					
		<input type="checkbox"/>	Option 9 (Injection below and surface)		<input type="checkbox"/>	Option 11 (Covering active sewage sludge unit daily)	
		<input type="checkbox"/>	Option 10 (Incorporation into soil within 6 hours)		<input type="checkbox"/>	None	
	4.22	Describe any treatment processes used at the active sewage sludge unit to reduce vector attraction properties of sewage sludge.					
		<input type="checkbox"/> Check here if you have attached your description to the application package.					
	Groundwater Monitoring						
	4.23	Is groundwater monitoring currently conducted at this active sewage sludge unit, or are groundwater monitoring data otherwise available for this active sewage sludge unit?					
		<input type="checkbox"/>	Yes		<input checked="" type="checkbox"/>	No → SKIP to Item 4.26 (Part 2, Section 4) below.	
	4.24	Provide a copy of available groundwater monitoring data.					
		<input type="checkbox"/> Check here to indicate you have attached the monitoring data.					
	4.25	Describe the well locations, the approximate depth to groundwater, and the groundwater monitoring procedures used to obtain these data.					
		<input type="checkbox"/> Check here if you have attached your description to the application package.					
	4.26	Has a groundwater monitoring program been prepared for this active sewage sludge unit?					
	<input type="checkbox"/>	Yes		<input type="checkbox"/>	No → SKIP to Item 4.28 (Part 2, Section 4) below.		
4.27	Submit a copy of the groundwater monitoring program with this permit application.						
	<input type="checkbox"/> Check here to indicate you have attached the monitoring program.						
4.28	Have you obtained a certification from a qualified groundwater scientist that the aquifer below the active sewage sludge unit has not been contaminated?						
	<input type="checkbox"/>	Yes		<input type="checkbox"/>	No → SKIP to Item 4.30 (Part 2, Section 4) below.		
4.29	Submit a copy of the certification with this permit application.						
	<input type="checkbox"/> Check here to indicate you have attached the certification to the application package.						
Site-Specific Limits							
4.30	Are you seeking site-specific pollutant limits for the sewage sludge placed on the active sewage sludge unit?						
	<input type="checkbox"/>	Yes		<input checked="" type="checkbox"/>	No → SKIP to Part 2, Section 5.		
4.31	Submit information to support the request for site-specific pollutant limits with this application.						
	<input type="checkbox"/> Check here to indicate you have attached the requested information.						

PART 2, SECTION 5 INCINERATION (40 CFR 122.21(q)(11))

Incineration	Incinerator Information	
	5.1	Do you fire sewage sludge in a sewage sludge incinerator? <input type="checkbox"/> Yes <input checked="" type="checkbox"/> No → SKIP to END.
	5.2	Indicate the total number of incinerators used at your facility. (Complete the remainder of Section 5 for each such incinerator.) <input type="checkbox"/> Check here to indicate that you have attached information for one or more incinerators.
	5.3	Incinerator name or number
		Location address (street, route number, or other specific identifier)
		County <input type="checkbox"/> Not available
		County code
		City or town
		State
		ZIP code
		Latitude/Longitude of Incinerator (see instructions)
		Latitude
		Longitude
		Method of Determination <input type="checkbox"/> USGS map <input type="checkbox"/> Field survey <input type="checkbox"/> Other (specify) _____
	Amount Fired	
5.4	Dry metric tons per 365-day period of sewage sludge fired in the sewage sludge incinerator:	
Beryllium NESHAP		
5.5	Submit information, test data, and a description of measures taken that demonstrate whether the sewage sludge incinerated is beryllium-containing waste and will continue to remain as such. <input type="checkbox"/> Check here to indicate that you have attached this material to the application package.	
5.6	Is the sewage sludge fired in this incinerator "beryllium-containing waste" as defined at 40 CFR 61.31? <input type="checkbox"/> Yes <input type="checkbox"/> No → SKIP to Item 5.8 (Part 2, Section 5) below.	
5.7	Submit with this application a complete report of the latest beryllium emission rate testing and documentation of ongoing incinerator operating parameters indicating that the NESHAP emission rate limit for beryllium has been and will continue to be met. <input type="checkbox"/> Check here to indicate that you have attached this information.	
Mercury NESHAP		
5.8	Is compliance with the mercury NESHAP being demonstrated via stack testing? <input type="checkbox"/> Yes <input checked="" type="checkbox"/> No → SKIP to Item 5.11 (Part 2, Section 5) below.	
5.9	Submit a complete report of stack testing and documentation of ongoing incinerator operating parameters indicating that the incinerator has met and will continue to meet the mercury NESHAP emission rate limit. <input type="checkbox"/> Check here to indicate that you have attached this information.	
5.10	Provide copies of mercury emission rate tests for the two most recent years in which testing was conducted. <input type="checkbox"/> Check here to indicate that you have attached this information.	
5.11	Do you demonstrate compliance with the mercury NESHAP by sewage sludge sampling? <input type="checkbox"/> Yes <input type="checkbox"/> No → SKIP to Item 5.13 (Part 2, Section 5) below.	
5.12	Submit a complete report of sewage sludge sampling and documentation of ongoing incinerator operating parameters indicating that the incinerator has met and will continue to meet the mercury NESHAP emission rate limit. <input type="checkbox"/> Check here to indicate that you have attached this information.	

Incineration Continued	Dispersion Factor	
	5.13	Dispersion factor in micrograms/cubic meter per gram/second:
	5.14	Name and type of dispersion model:
	5.15	Submit a copy of the modeling results and supporting documentation. <input type="checkbox"/> Check here to indicate that you have attached this information.
	Control Efficiency	
	5.16	Provide the control efficiency, in hundredths, for each of the pollutants listed below.
		Pollutant
		Control Efficiency, in Hundredths
		Arsenic
		Cadmium
		Chromium
		Lead
		Nickel
	5.17	Attach a copy of the results or performance testing and supporting documentation (including testing dates). <input type="checkbox"/> Check here to indicate that you have attached this information.
	Risk-Specific Concentration for Chromium	
	5.18	Provide the risk-specific concentration (RSC) used for chromium in micrograms per cubic meter:
	5.19	Was the RSC determined via Table 2 in 40 CFR 503.43? <input type="checkbox"/> Yes <input type="checkbox"/> No → SKIP to Item 5.21 (Part 2, Section 5) below.
	5.20	Identify the type of incinerator used as the basis. <input type="checkbox"/> Fluidized bed with wet scrubber <input type="checkbox"/> Other types with wet scrubber <input type="checkbox"/> Fluidized bed with wet scrubber and wet electrostatic precipitator <input type="checkbox"/> Other types with wet scrubber and wet electrostatic precipitator
	5.21	Was the RSC determined via Table 6 in 40 CFR 503.43 (site-specific determination)? <input type="checkbox"/> Yes <input type="checkbox"/> No → SKIP to Item 5.23 (Part 2, Section 5) below.
	5.22	Provide the decimal fraction of hexavalent chromium concentration to total chromium concentration in stack exit gas:
	5.23	Attach the results of incinerator stack tests for hexavalent and total chromium concentrations, including the date(s) of any test(s), with this application. <input type="checkbox"/> Check here to indicate that you have attached this information. <input type="checkbox"/> Not applicable
	Incinerator Parameters	
	5.24	Do you monitor total hydrocarbons (THC) in the exit gas of the sewage sludge incinerator? <input type="checkbox"/> Yes <input type="checkbox"/> No
	5.25	Do you monitor carbon monoxide (CO) in the exit gas of the sewage sludge incinerator? <input type="checkbox"/> Yes <input type="checkbox"/> No
	5.26	Indicate the type of sewage sludge incinerator.
	5.27	Incinerator stack height in meters:
	5.28	Indicate whether the value submitted in Item 5.27 is (check only one response): <input type="checkbox"/> Actual stack height <input type="checkbox"/> Creditable stack height

EPA Identification Number AL0082848		NPDES Permit Number AL0082848	Facility Name Gilbertown WRRF	Form Approved 03/05/19 OMB No. 2040-0004	
Incineration Continued	Performance Test Operating Parameters				
	5.29	Maximum performance test combustion temperature:			
	5.30	Performance test sewage sludge feed rate, in dry metric tons/day			
	5.31	Indicate whether value submitted in Item 5.30 is (check only one response): <input type="checkbox"/> Average use <input type="checkbox"/> Maximum design			
	5.32	Attach supporting documents describing how the feed rate was calculated. <input type="checkbox"/> Check here to indicate that you have attached this information.			
	5.33	Submit information documenting the performance test operating parameters for the air pollution control device(s) used for this sewage sludge incinerator. <input type="checkbox"/> Check here to indicate that you have attached this information.			
	Monitoring Equipment				
	5.34	List the equipment in place to monitor the listed parameters.			
		Parameter	Equipment in Place for Monitoring		
		Total hydrocarbons or carbon monoxide			
		Percent oxygen			
		Percent moisture			
		Combustion temperature			
		Other (describe)			
Air Pollution Control Equipment					
5.35	List all air pollution control equipment used with this sewage sludge incinerator. <input type="checkbox"/> Check here if you have attached the list to the application package for the noted incinerator.				

END of PART 2

Submit completed application package to your NPDES permitting authority.